User Manual

SG33CX

SG40CX

SG50CX

PV Grid-Connected Inverter



All Rights Reserved

No part of this document can be reproduced in any form or by any means without the prior written permission of Sungrow Power Supply Co., Ltd.

Trademarks

SUNGROW and other Sungrow trademarks used in this manual are owned by Sungrow Power Supply Co., Ltd.

All other trademarks or registered trademarks mentioned in this document are owned by their respective owners.

Software Licenses

It is prohibited to use data contained in firmware or software developed by SUNGROW, in part or in full, for commercial purposes by any means.

It is prohibited to perform reverse engineering, cracking, or any other operations that compromise the original program design of the software developed by SUNGROW.

Sungrow Power Supply Co., Ltd.

Address: No.1699 Xiyou Rd., New & High Tech Zone, Hefei, 230088, China.

Email: info@sungrow.cn

Tel: +86 551 6532 7834

Website: www.sungrowpower.com

About This Manual

The manual mainly describes the product information, guidelines for installation, operation and maintenance. The manual cannot include complete information about the photovoltaic (PV) system. You can get additional information about other devices at www.sungrowpower.com or on the webpage of the respective component manufacturer.

Applicability

This manual is applicable to the following inverter types:

- SG33CX
- SG40CX
- SG50CX

They will be referred to as “inverter” hereinafter unless otherwise specified.

Target Group

- Plant owner
- Installation engineer
- Maintenance engineer





How to Use This Manual

Read the manual and other related documents before any work on the inverter is carried out. Documents must be stored carefully and be available at all times.

The contents of the manual will be periodically updated or revised due to the product development. It is probably that there are changes of manual in the subsequent inverter edition. The latest manual can be acquired via visiting the website at www.sungrowpower.com.

Symbols

Important instructions contained in this manual should be followed during installation, operation and maintenance of the inverter. They will be highlighted by the following symbols.

| Symbol | Explanation |
|--|--|
|  DANGER | Indicates a hazard with a high level of risk that, if not avoided, will result in death or serious injury. |
|  WARNING | Indicates a hazard with a medium level of risk that, if not avoided, could result in death or serious injury. |
|  CAUTION | Indicates a hazard with a low level of risk that, if not avoided, could result in minor or moderate injury. |
| NOTICE | Indicates a situation that, if not avoided, could result in equipment or property damage. |
|  | Indicates additional information, emphasized contents or tips that may be helpful, e.g. to help you solve problems or save time. |

Contents

| | |
|--|-----------|
| About This Manual | II |
| 1 Safety..... | 1 |
| 1.1 PV Panels..... | 1 |
| 1.2 Utility Grid..... | 1 |
| 1.3 Inverter..... | 2 |
| 1.4 Skills of Qualified Personnel..... | 3 |
| 2 Product Introduction..... | 4 |
| 2.1 Intended Usage..... | 4 |
| 2.2 Product Introduction..... | 5 |
| 2.2.1 Type Description..... | 5 |
| 2.2.2 Appearance | 6 |
| 2.2.3 Dimensions..... | 7 |
| 2.2.4 LED Indicator Panel..... | 7 |
| 2.2.5 DC Switch..... | 8 |
| 2.3 Circuit Diagram | 8 |
| 2.4 Function Description..... | 9 |
| 3 Unpacking and Storage..... | 11 |
| 3.1 Unpacking and Inspection | 11 |
| 3.2 Identifying the Inverter..... | 11 |
| 3.3 Scope of Delivery..... | 13 |
| 3.4 Inverter Storage..... | 13 |
| 4 Mechanical Mounting..... | 15 |
| 4.1 Safety during Mounting..... | 15 |
| 4.2 Location Selection..... | 15 |
| 4.2.1 Installation Environment Requirements..... | 16 |
| 4.2.2 Carrier Requirements..... | 16 |
| 4.2.3 Installation Angle Requirements..... | 16 |

| | | |
|----------|---|-----------|
| 4.2.4 | Installation Clearance Requirements | 17 |
| 4.3 | Installation Tools | 18 |
| 4.4 | Moving the Inverter | 19 |
| 4.4.1 | Manual Transport..... | 19 |
| 4.4.2 | Hoisting Transport..... | 20 |
| 4.5 | PV Bracket-Mounted Installation..... | 21 |
| 4.5.1 | Preparation before Mounting..... | 21 |
| 4.5.2 | Mounting Steps..... | 22 |
| 4.6 | Wall-Mounted Installation | 24 |
| 4.6.1 | Preparation before Mounting..... | 24 |
| 4.6.2 | Mounting Steps..... | 24 |
| 5 | Electrical Connection..... | 28 |
| 5.1 | Safety Instructions..... | 28 |
| 5.2 | Terminal Description | 28 |
| 5.3 | Electrical Connection Overview | 29 |
| 5.4 | Additional Grounding Connection | 31 |
| 5.4.1 | Additional Grounding Requirements..... | 31 |
| 5.4.2 | Connection Procedure..... | 31 |
| 5.5 | AC Cable Connection | 32 |
| 5.5.1 | AC Side Requirements..... | 32 |
| 5.5.2 | Cold Press Terminal Requirements..... | 34 |
| 5.5.3 | Aluminium Cable Requirements..... | 35 |
| 5.5.4 | Connection Procedure..... | 35 |
| 5.6 | PV String Connection | 38 |
| 5.6.1 | PV Input Configuration..... | 38 |
| 5.6.2 | Connection Procedure..... | 39 |
| 5.6.3 | Installing the PV Connectors..... | 40 |
| 5.7 | Communication Junction Box | 41 |
| 5.7.1 | Remove the Junction Box..... | 41 |
| 5.7.2 | Install the Junction Box | 42 |
| 5.8 | Communication Wiring Board | 42 |
| 5.9 | RS485 Communication | 43 |

| | | |
|----------|--|-----------|
| 5.9.1 | Interface Description..... | 43 |
| 5.9.2 | RS485 Communication System..... | 44 |
| 5.9.3 | Connection Procedure..... | 46 |
| 5.10 | Dry Contact Connection..... | 49 |
| 5.11 | Communication Module Connection (optional) | 52 |
| 6 | Commission..... | 54 |
| 6.1 | Inspection before Commissioning..... | 54 |
| 6.2 | Commissioning Procedure | 54 |
| 7 | iSolarCloud APP | 55 |
| 7.1 | Brief Introduction..... | 55 |
| 7.2 | Download and Install | 55 |
| 7.3 | Menu..... | 56 |
| 7.4 | Login..... | 56 |
| 7.4.1 | Requirements | 56 |
| 7.4.2 | Login Steps | 57 |
| 7.5 | Home page..... | 58 |
| 7.6 | Running Information..... | 60 |
| 7.7 | History Record | 62 |
| 7.7.1 | Fault Alarm Records..... | 62 |
| 7.7.2 | Power Yields Records..... | 63 |
| 7.7.3 | Event Records | 64 |
| 7.8 | More..... | 64 |
| 7.8.1 | Parameter Setting..... | 65 |
| 7.8.2 | Password Changing..... | 65 |
| 8 | System Decommissioning | 66 |
| 8.1 | Disconnecting the Inverter..... | 66 |
| 8.2 | Dismantling the Inverter | 66 |
| 8.3 | Disposal of the Inverter..... | 67 |
| 9 | Troubleshooting and Maintenance | 68 |
| 9.1 | Troubleshooting | 68 |
| 9.2 | Maintenance | 76 |

| | |
|------------------------------------|-----------|
| 9.2.1 Routine Maintenance..... | 77 |
| 9.2.2 Maintenance Instruction..... | 77 |
| 10 Appendix | 80 |
| 10.1 Technical Data | 80 |
| 10.2 Quality Assurance..... | 82 |
| 10.3 Contact Information | 83 |

1 Safety

The inverter has been designed and tested strictly according to international safety regulations. Read all safety instructions carefully prior to any work and observe them at all times when working on or with the inverter.

Incorrect operation or work may cause:

- injury or death to the operator or a third party; or
- damage to the inverter and other property safety of the operator or a third party.

All detailed work-related safety warnings and notes will be specified at critical points in this manual.



- The safety instructions in this manual cannot cover all the precautions that should be followed. Perform operations considering actual onsite conditions.
- Sungrow shall not be held liable for any damage caused by violation of the safety instructions in this manual.

1.1 PV Panels

DANGER

PV strings will produce electrical power when exposed to sunlight and can cause a lethal voltage and an electric shock.

- **Always keep in mind that the inverter is dual power supplied. Electrical operators must wear proper personal protective equipment: helmet, insulated footwear, glove, etc.**
- **Before touching the DC cables, operator must use a measuring device to ensure that the cable is voltage-free.**
- **Must follow all warnings on the PV strings and in its manual.**

1.2 Utility Grid

Please follow the regulations related to the utility grid.

NOTICE

- All electrical connections must be in accordance with local and national standards.
- Only with the permission of the utility grid, the inverter can be connected to the utility grid.

1.3 Inverter

 DANGER

Danger to life from electric shocks due to live voltage

- Do not open the enclosure at any time. Unauthorized opening will void guarantee and warranty claims and in most cases terminate the operating license.

 WARNING

Risk of inverter damage or personal injury

- Do not pull out the PV connectors when the inverter is running.
- Wait 5 minutes for the internal capacitors to discharge. Ensure that there is no voltage or current before pulling any connector.

 WARNING

All safety instructions, warning labels, and nameplate on the inverter:

- Must be clearly visible;
- Should not be removed or covered.

 CAUTION

Risk of burns due to hot components!

Do not touch any hot parts (such as heat sink) during operation. Only the DC switch can safely be touched at any time.

NOTICE

Only qualified personnel can perform the country setting.





Unauthorized alteration of the country setting may cause a breach of the type-certificate marking.

Risk of inverter damage due to electrostatic discharge (ESD).

By touching the electronic components, you may damage the inverter. For inverter handling, be sure to:

- **Avoid any unnecessary touching;**
- **Wear a grounding wristband before touching any connectors.**

Warning Label

| Label | Description |
|---|---|
|  | Danger to life due to high voltages! Only qualified personnel can open and service the inverter. |
|  | Disconnect the inverter from all the external power sources before service! |
|  | Do not touch live parts until 5minutes after disconnection from the power sources. |
|  | There is a danger from a hot surface that may exceed 60°C. |
|  | Check the user manual before service! |

1.4 Skills of Qualified Personnel

All installations should be performed by technical personnel. They should have:

- Training in the installation and commissioning of the electrical system, as well as the dealing with hazards;
- Knowledge of the manual and other related documents;
- Knowledge of the local regulations and directives.

2 Product Introduction

2.1 Intended Usage

SG33CX, SG40CX, SG50CX, a transformerless three-phase PV grid-connected inverter, is an integral component in the PV power system.

The inverter is designed to convert the direct current power generated from the PV modules into grid-compatible AC current and feeds the AC current to the utility grid. The intended usage of the inverter is illustrated in Fig. 2-1.

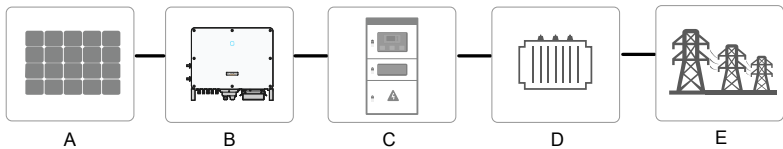

Fig. 2-1 Inverter application in PV power system

WARNING

Inverter cannot connect the PV strings whose positive and negative terminals need to be grounded.

Do not connect any local load between the inverter and the AC circuit breaker.

| Item | Description | Note |
|------|-------------------------|---|
| A | PV strings | Monocrystalline silicon, polycrystalline silicon and thin-film without grounding. |
| B | Inverter | SG33CX, SG40CX, SG50CX. |
| C | Grid connection cabinet | Includes devices such as AC circuit breaker, SPD, metering device. |
| D | Transformer | Convert the inverter output low-voltage AC voltage into the grid-compatible medium-voltage level. |
| E | Utility grid | TN-C, TN-S, TN-C-S, TT, IT |

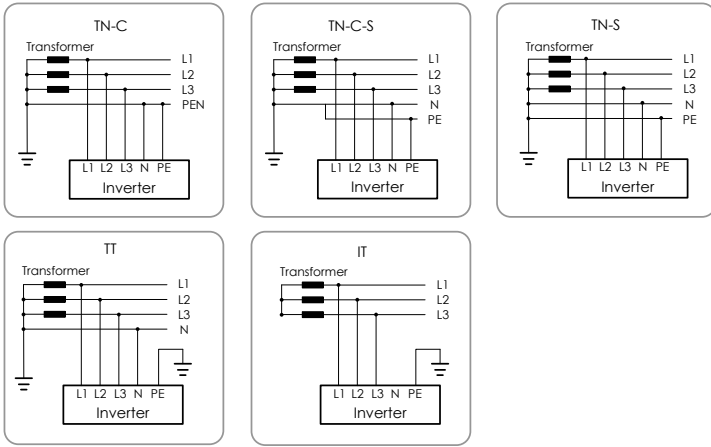

2.2 Product Introduction

2.2.1 Type Description

The device type description is as follows (Take SG33CX as an example):

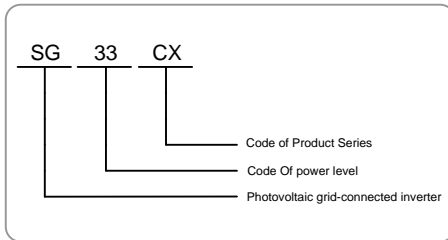

Tab. 2-1 Power Level Description

| Type | Nominal Output Power | Nominal Grid Voltage |
|--------|----------------------|-------------------------|
| SG33CX | 33000W | 3 / N / PE , 230 / 400V |
| SG40CX | 40000W | |
| SG50CX | 50000W | |

The device type can be found on the nameplate attached to the side of the inverter. For details, refer to Fig. 3-1Nameplate.

2.2.2 Appearance

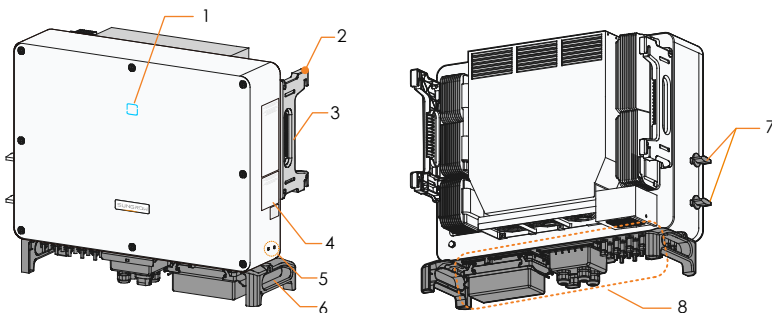

*The image shown here is for reference only. The actual product you receive may differ.

| No. | Name | Description |
|-----|--------------------------------|--|
| 1 | LED indicator panel | HMI interface to indicate the present working state of the inverter. |
| 2 | Mounting ears | 4, used to hang the inverter onto the mounting-bracket. |
| 3 | Side handles | 2, used to move the inverter. |
| 4 | Labels | Warning symbols, nameplate, and QR code. |
| 5 | Additional grounding terminals | 2, Use at least one of them to ground the inverter. |
| 6 | Bottom handles | 2, used to move the inverter. |
| 7 | DC switches | To disconnect the DC current safely. |
| 8 | Wiring area | DC switches, AC terminals, DC terminals, and communication terminals. For details, refer to REF_Ref5624495 \r \h 5.2 Terminal Description |

2.2.3 Dimensions

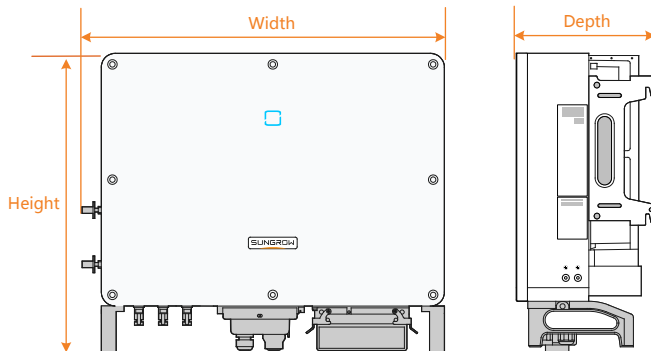





Fig. 2-2 Dimensions of the Inverter

| Type | Dimensions (W*H*D) | Weight |
|--------|--------------------|--------|
| SG33CX | 702×595×310mm | 50 kg |
| SG40CX | 782×645×310mm | 58 kg |
| SG50CX | 782×645×310mm | 62kg |

2.2.4 LED Indicator Panel

As an HMI, the LED indicator panel on the inverter front panel indicates the present working state of the inverter.

Tab. 2-2 LED indicator description

| LED indicator | LED state | Definition |
|---|---|--|
|  | Steady Blue | The device is connected to the grid and operating normally. |
| | Flashing blue (fast)  | The Bluetooth communication is connected and there is data communication. No inverter fault occurs. |
| | Flashing blue (slow)  | The DC or AC side is powered on and the device is in standby or startup state (not feeding power into the grid). |
| | Steady Red | A fault occurs and the device cannot connect to the grid |
| | Flashing Red | The Bluetooth communication is connected and there is data communication. Fault occurs. |
| | OFF | Both the AC and DC sides are powered down. |

2.2.5 DC Switch

The DC switch is used to disconnect the DC current safely whenever necessary.

The SG33CX is equipped with one DC switch to control the connection/disconnection of all DC terminals.

The SG40CX and SG50CX are equipped with two DC switches separately controlling a group of DC inputs. The correspondence is as follows:

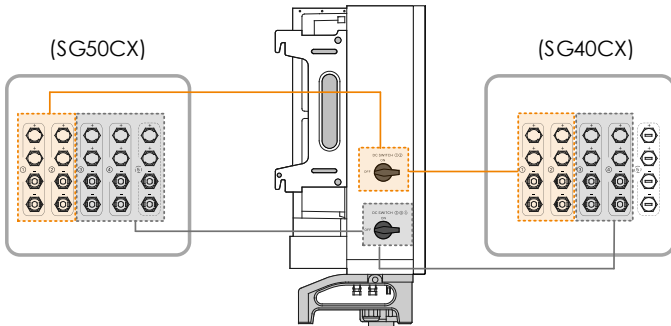

2.3 Circuit Diagram

The MPPT is utilized for DC input to ensure the maximum power from the PV array at different PV input conditions. The inversion circuit converts the DC power into AC power and feeds the AC power into the utility grid through the AC terminal. The protection circuit is equipped to ensure the safe operation of the device and personal safety.

Fig. 2-3 shows the main circuit of the inverter.

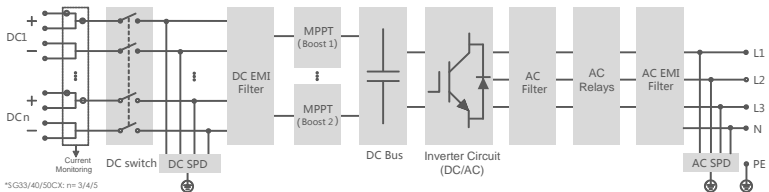

Fig. 2-3 Circuit diagram

2.4 Function Description

The inverter is equipped with the following functions:

- Inversion function

The inverter converts the DC current into grid-compatible AC current and feeds the AC current into the grid.

- Data storage

The inverter achieves the running information, fault records and etc.

- Parameter Configuration

The inverter provides various parameter settings. You can set the parameters via the phone's APP to change the requirements of the device or optimize the performance of the device.

- Communication Interface

Standard RS485 port can be connected to monitoring a device and PV system.

Communication accessory port is provided to which communication module can be connected, thereby achieving the communication function and connecting the monitoring device to the whole PV system.



- The communication module is a device that collects inverter data of the PV power plant in real time and realizes remote data collection and remote O&M functions.
- It is recommended to use the communication module produced by Sungrow, such as Eye, WiFi, or E-Net. A third-party communication device may cause communication failure or even unpredictable damage.

- Protection Function

The protective functions are integrated in the inverter, including anti-island protection, LVRT/ZVRT, DC reversed polarity protection, AC short circuit protection, leakage current protection, DC overvoltage/overcurrent protection, etc.

PID function

After the PID function is enabled, the voltage to ground of all PV panels is greater than 0, that is, the PV panel-to-ground voltage is a positive value.

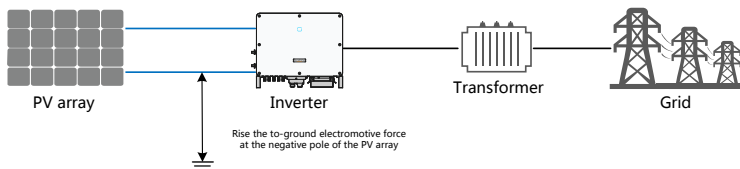

NOTICE

Before enabling the PID recovery function, make sure the to-ground voltage polarity of the PV panels meets requirement. If there are any questions, contact the PV panel manufacturer or read its corresponding user manual.

If the voltage scheme for the PID protection/recovery function does not meet the requirement of corresponding PV panels, the PID function will not work as expected or even damage the PV panels.

PID recovery function

When the inverter is not running, the PID module will apply inverse voltage to PV panels, to restore the degraded modules.



- If the PID recovery function is enabled, it only works at night.
- After the PID recovery function is enabled, the voltage of the PV string to ground is 500Vdc by default, and the default value can be modified by the APP.

3 Unpacking and Storage

3.1 Unpacking and Inspection

The inverter is thoroughly tested and strictly inspected before delivery. Damage may still occur during shipping. Conduct a thorough inspection after receiving the device.

- Check the packing case for any visible damage.
- Check the inner contents for damage after unpacking.
- Check the delivery scope for completeness according to the packing list.

Contact SUNGROW or the distributor in case of any damaged or missing components.

It is the best choice to store the inverter in the original packing case. So, do not dispose of it.

3.2 Identifying the Inverter

The nameplate can be found on both the inverter and the packing case. It provides information on type of inverter, important specifications, marks of certification institutions, and serial number which are available and identified by Sungrow. Take SG33CX as an example:

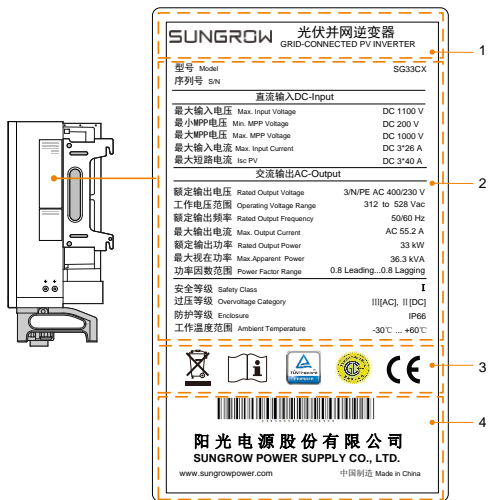

Fig. 3-1 Nameplate

* The image shown here is for reference only. The actual product you receive may differ.

| Item | Description |
|------|--|
| 1 | SUNGROW logo and product type |
| 2 | Technical data of inverter |
| 3 | Marks of certification institutions of inverter |
| 4 | Company name, website and country of manufacture |

Tab. 3-1 Description of Icons on the Nameplate

| Icon | Description |
|------|---|
| | Do not dispose of the inverter together with household waste. |
| | Refer to the corresponding instructions. |
| | TÜV mark of conformity. |
| | CGC-SOLAR mark of conformity. |
| | CE mark of conformity. |

3.3 Scope of Delivery

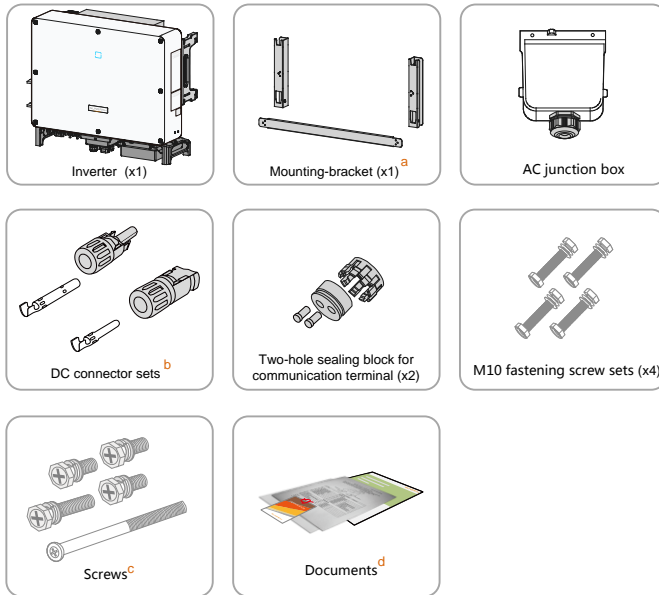

Fig. 3-2 Scope of Delivery

a: The mounting-bracket includes 2 mounting-bracket components and 1 connecting bar.

b: The SG33CX, SG40CX, and SG50CX are respectively provided with 6, 8, and 10 pairs of DC connectors and cord end terminals.

c: The screws include 1 M4×25 screw, 3 M4×10 screws, and 2 M6×65 screws.

d: The documents include the quick guidance, packing list, warranty card, etc.

3.4 Inverter Storage

Store the inverter properly when the inverter is not to be installed immediately.

- Store the inverter in the original packing case with the desiccant inside.

- The storage temperature should be always between -40°C and $+70^{\circ}\text{C}$, and the storage relative humidity should be always between 0 and 95 %, non-condensing.
- In case of stacking storage, the number of stacking layers should never exceed the limit marked on the outer side of the packing case.

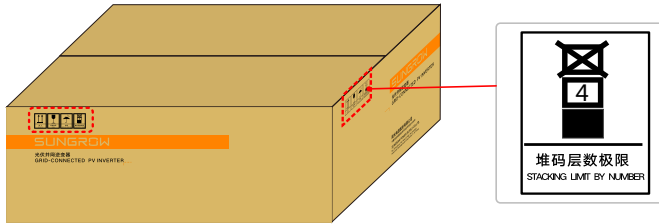

- The packing case should be upright.

If the inverter has been stored more than half a year, the qualified personnel should thoroughly check and test it before using.

4 Mechanical Mounting

4.1 Safety during Mounting

DANGER

Make sure there is no electrical connection before installation.

In order to avoid electric shock or other injury, be sure there is no electricity or plumbing installations before drilling holes.

CAUTION

Risk of injury due to improper handling

- The weight may cause injuries, serious wounds, or bruise.
- Always follow the instructions when moving and positioning the inverter.

System performance loss due to poor ventilation!

- Keep the heat sinks uncovered to ensure heat dissipation performance.

4.2 Location Selection

Selecting an optimal location for the inverter is critical to safe operation, long service life, and sound performance.

With ingress of protection IP66, the inverter can be installed both indoors and outdoors.

The inverter should be installed in a place convenient for electrical connection, operation, and maintenance.

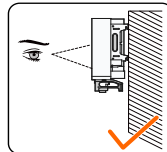
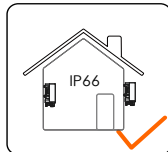

4.2.1 Installation Environment Requirements

- The installation environment is free of inflammable materials.
- The inverter should be installed in a place inaccessible to the children.
- The ambient temperature and relative humidity should meet the following requirements.

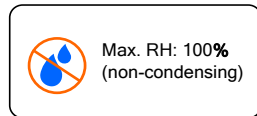
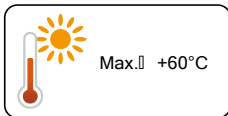

- The inverter should be protected against exposure to direct sunlight, rain, or snow to ensure longer service life.
- The inverter should be well ventilated. Ensure air circulation.
- Never install the inverter in enclosed areas. Otherwise, it will not normally operate.

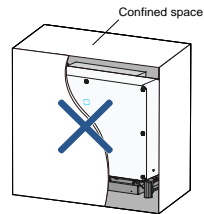

- Never install the inverter in living areas. The inverter will generate noise during operation, affecting daily life.

4.2.2 Carrier Requirements

- The installation carrier should meet the following requirements:



Made of non-flammable materials



Max. load bearing capacity \geq 4 times of inverter weight

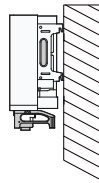

4.2.3 Installation Angle Requirements

- Install the inverter vertically or at a maximum back tilt of 80°. Forward installation or upside down installation is prohibited.

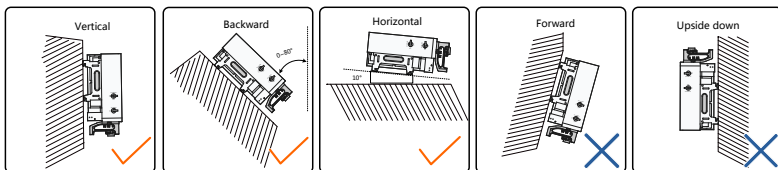

4.2.4 Installation Clearance Requirements

- Reserve enough clearance around the inverter to ensure sufficient space for heat dissipation. (The fans are maintained on the left side of the inverter, and a larger clearance is required.)

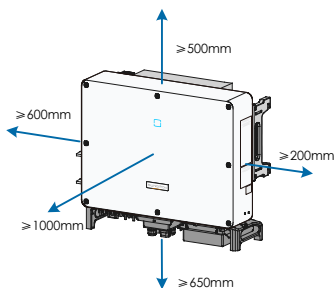

- In case of multiple inverters, reserve specific clearance between the inverters.

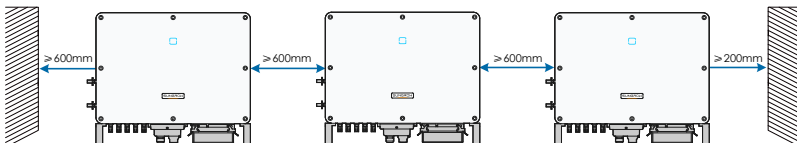



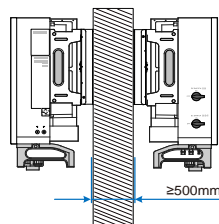









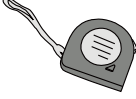

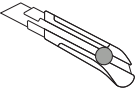
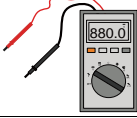
- In case of back-to-back installation, reserve specific clearance between the two inverters.



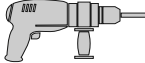

- Install the inverter at an appropriate height for ease of viewing LED indicators and operating switches.

4.3 Installation Tools

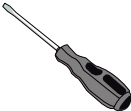
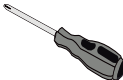
Prepare the following tools before installation:

| Type | Tool | | | |
|---------------|---|---|--|--|
| General tools | Packaging tape  | Marker  | Measuring tape  | Level  |
| | Utility knife  | Multimeter Measurement range: $\geq 1100\text{Vdc}$  | Protective clothing  | Wrist strap  |
| | Protective gloves  | Dust mask  | Earplugs  | Goggles  |
| | Insulated shoes  | Vacuum cleaner  | - | - |
| | Hammer drill Drill bit: $\phi 12$, $\phi 14$  | Rubber mallet  | Slotted screwdriver  | Phillips screwdriver Specification: M4, M6  |

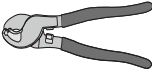
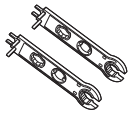
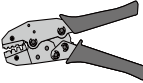
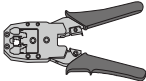
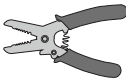
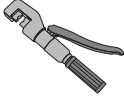
| Type | Tool | | | |
|------|---|---|--|--|
| | Wrench Opening:16mm  | Socket wrench  | Wire cutter  | MC4 terminal wrench  |
| | crimping tool  | RJ45 crimping tool  | Wire stripper  | Hydraulic pliers  |

- Other auxiliary tools that may be used

4.4 Moving the Inverter

Move the inverter to the specified position before installation. The inverter can be moved manually or via a hoist.

4.4.1 Manual Transport

Lift and move the inverter to the destination by using the side handles and bottom handles.

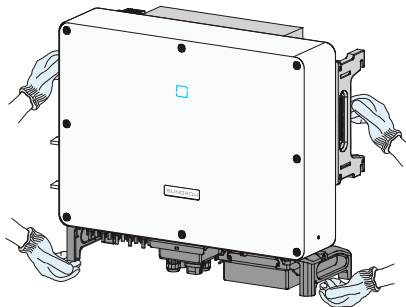

⚠ CAUTION

- Inappropriate moving operation may cause personal injury!
- It is recommended that at least two installers carry the inverter together and wear protective equipment such as smash-proof shoes and gloves.
- Always beware of the gravity center of the inverter and avoid tipping.

NOTICE

The ground surface on which the inverter is to be placed should be covered with a sponge pad, foam cushion or the like to prevent the inverter bottom from scratches.

4.4.2 Hoisting Transport

Step 1 Release the sealing screws on the mounting ears and store them properly.

Step 2 Anchor two M12 thread lifting rings to the hangers of the inverter.

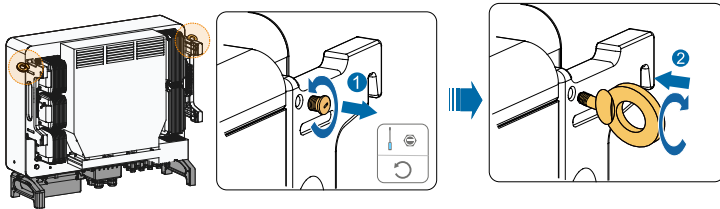

Step 3 Lead the sling through the two lifting rings and fasten the tie-down strap.

Step 4 Hoist the inverter, and stop to check for safety when the inverter is 100mm above the ground. Continue hoisting the device to the destination after ensuring the safety.

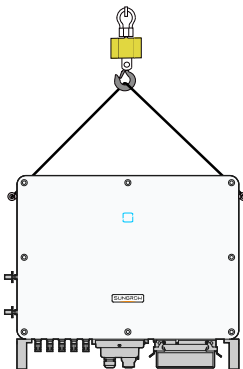

Step 5 Remove the lifting rings and reassemble the sealing screws released in Step 1.

⚠ CAUTION

Keep the inverter balanced throughout the hoisting process and avoid collisions with walls or other objects.

Stop hoisting in the event of severe weather, such as heavy rain, thick fog, or strong wind.



The lifting rings and the sling are not within the delivery scope.

4.5 PV Bracket-Mounted Installation

4.5.1 Preparation before Mounting

Tools

| Item | Specification |
|---|-----------------------------|
| Phillips screwdriver/ electric screw driver | M4, M6 |
| Marker | - |
| Level | - |
| Hammer drill | Drill bit: $\varnothing 12$ |
| Socket wrench | Including 16mm socket |

Spare parts

| Item | Quantity | Specification | Source |
|---------------|----------|---------------|----------------|
| Grub screw | 2 | M4×10 | Delivery scope |
| | 2 | M6×65 | Delivery scope |
| Bolt assembly | 4 | M10 | Delivery scope |

4.5.2 Mounting Steps

Step 1 Assemble the mounting-bracket by using the connecting bar.

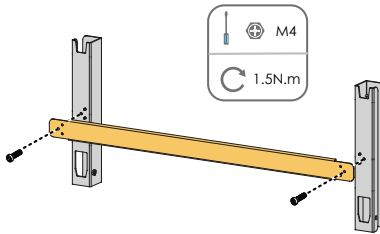

Step 2 Level the assembled mounting-bracket by using the level, and mark the positions for drilling holes on the PV bracket.

Step 3 Drill the holes by using a hammer drill.

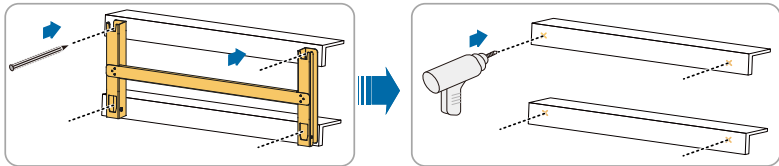

Step 4 Secure the mounting-bracket with bolts.

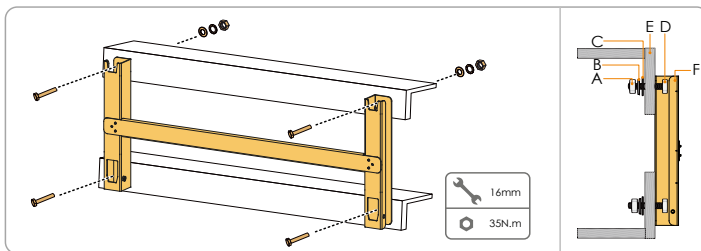

Tab. 4-1 Fastening sequence

| No. | Components | Description |
|-----|--------------------|-------------|
| A | Hex nuts | M10 |
| B | Spring washer | - |
| C | Flat washer | - |
| D | Full threaded bolt | M10*45 |
| E | Metal bracket | - |
| F | Mounting-bracket | - |

Step 5 Take out the inverter from the packing case.

Step 6 Hoist the inverter to the installation position when necessary (refer to 4.4.2 Hoisting Transport). If the installation position is not high enough, skip performing this step.

Step 7 Hang the inverter to the mounting-bracket and ensure that the mounting ears perfectly engage with the mounting-bracket.

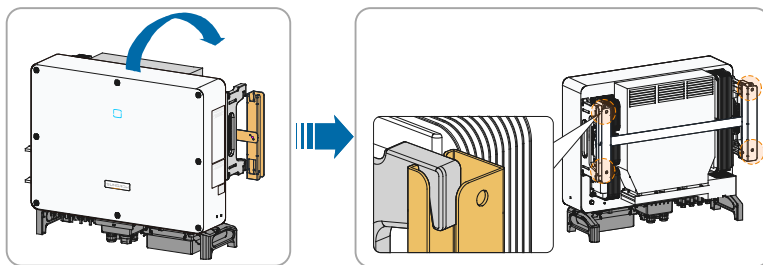

Step 8 Fix the inverter with two M6×65 screws.

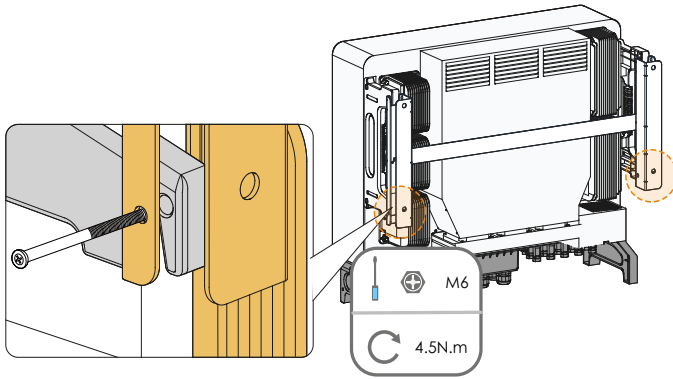

4.6 Wall-Mounted Installation

4.6.1 Preparation before Mounting

Tools

| Item | Specification |
|--|--|
| Phillips screwdriver/ electric screw driver | M4, M6 |
| Marker | - |
| Level | - |
| Hammer drill | Drill bit(Select according to expansion bolt specifications) |
| Socket wrench | Including 16mm socket |
| Wrench | Opening: 16mm |

Spare parts

| Item | Quantity | Specification | Source |
|-----------------|----------|----------------------|----------------|
| Grub screw | 2 | M4×10 | Delivery scope |
| | 2 | M6×65 | Delivery scope |
| Expansion bolts | 4 | M10×95 (Recommended) | Self-prepared |

4.6.2 Mounting Steps

Step 1 Assemble the mounting-bracket by using the connecting bar.

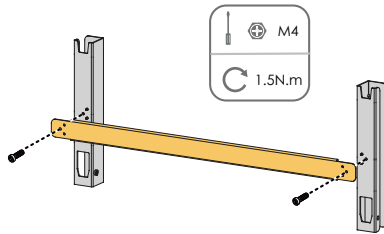

Step 2 Level the assembled mounting-bracket by using the level, and mark the positions for drilling holes on the installation site.

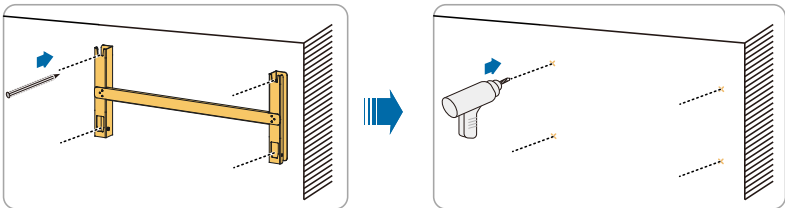

Step 3 Insert the expansion bolts into the holes and secure them with a rubber hammer. Fasten the nut with a wrench to expand the bolt. Remove the nut, spring washer, and flat washer, and store them properly.

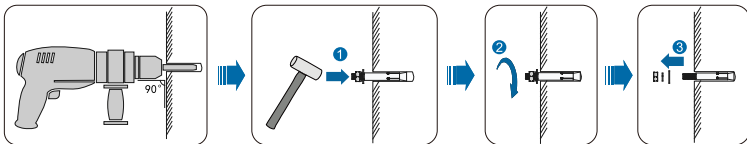

Step 4 Fix the mounting-bracket with the expansion bolts.

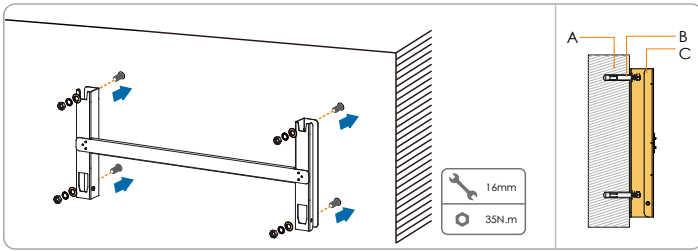

Tab. 4-2 Fastening sequence

| Item | Designation | Description |
|------|------------------|---|
| A | Wall | - |
| B | Expansion bolt | Fastening the bolt in the sequence of nut, spring washer, slat washer |
| C | Mounting-bracket | - |

Step 5 Take out the inverter from the packing case.

Step 6 Hoist the inverter to the installation position when necessary (refer to 4.4.2 Hoisting Transport). If the installation position is not high enough, skip performing this step.

Step 7 Hang the inverter to the mounting-bracket and that the mounting ears perfectly engage with the mounting-bracket.

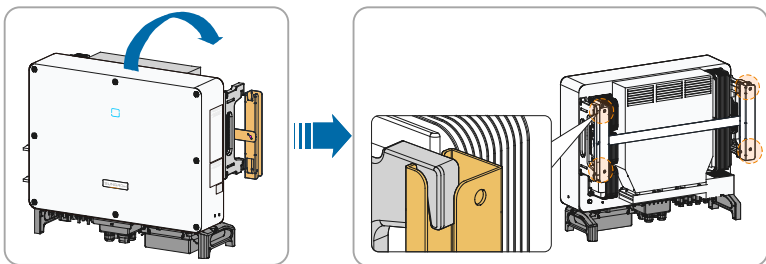

Step 8 Fix the inverter with screws.

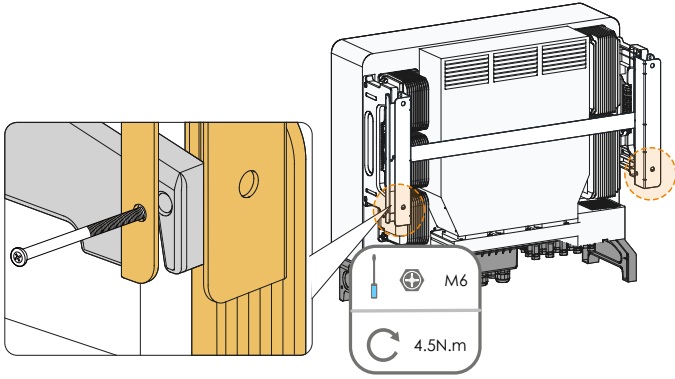

5 Electrical Connection

5.1 Safety Instructions

DANGER

High voltage may be present inside the inverter!

- The PV string will generate lethal high voltage when exposed to sunlight.
- Do not connect AC&DC circuit breakers before finishing electrical connections.
- Ensure all cables are voltage free before performing cable connection.

WARNING

- Any improper operations during cable connection can cause device damage or personal injury.
- Only qualified personnel can perform cable connection.
- All cables must be undamaged, firmly attached, properly insulated and adequately dimensioned.

NOTICE

Comply with the safety instructions related to the PV strings and the regulations related to the utility grid.

- All electrical connections must be in accordance with local and national standards.
- Only with the permission of the utility grid, the inverter can be connected to the utility grid.

5.2 Terminal Description

Wiring terminals are at the bottom of the inverter, as shown in the figure below.

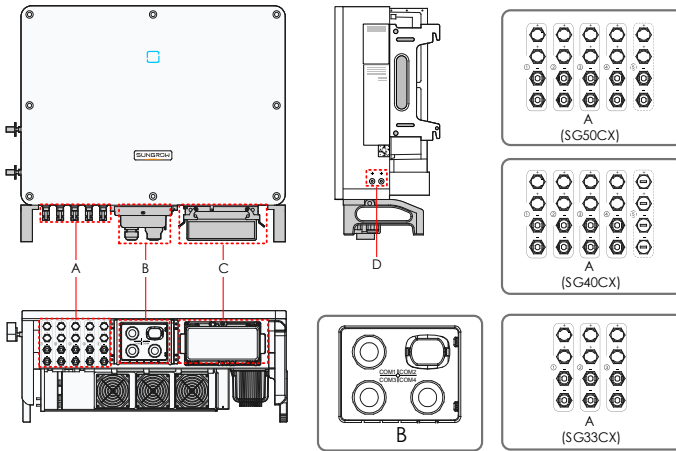

Fig. 5-1 Wiring terminals

* Figure shown here is for reference only. The actual product you receive may differ

| Item | Terminal | Print | Note |
|------|-------------------------------|--------------|---|
| A | PV terminals | + / - | MC4 PV connector SG33CX: 6 pairs of terminals SG40CX: 8 pairs of terminals SG50CX: 10 pairs of terminals |
| B | Communication terminal | COM1/ 3/4 | For RS485 communication, digital input and output DI/DO and DRM communication wiring. |
| | | COM2 | Communication module connection, such as GPRS, WiFi, and E-Net |
| C | AC junction box | - | Remove the protective case and use the junction box in the shipping accessory for wiring. |
| D | Additional grounding terminal | | 2, use at least one of them to ground the inverter |

5.3 Electrical Connection Overview

Electrical connection in the PV system includes additional grounding connection, grid connection, and PV string connection.

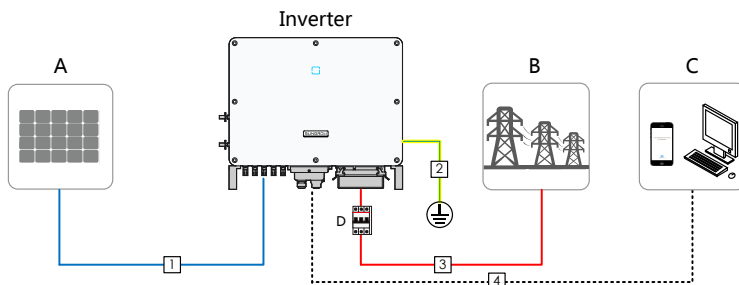

| Item | Designation |
|------|--------------------|
| A | PV string |
| B | Grid |
| C | Monitoring device |
| D | AC circuit breaker |

Tab. 5-1 Cable requirements

| N o. | Cable | Type | Specification | |
|------|----------------------------|---|---------------------|---|
| | | | Outer diameter (mm) | Cross section (mm ²) |
| 1 | DC cable | PV cable complying with 1,500V standard | 6~9 | 4~6 |
| 2 | Additional Grounding cable | Outdoor single-core copper wire cable | / | The same as that of the PE wire in the AC cable |
| 3 | AC cable | Outdoor multi-core copper or aluminium cable (Copper and aluminium adapter terminals are required when using aluminium cable) | 25~50 | Phase wire(SG33CX): 16~35 Phase wire(SG40CX): 25~50 Phase wire(SG50CX): 35~70 PE wire: refer to Tab. 5-2 |
| 4 | Communication cable | Shielded twisted pair (terminal block) CAT-5 Ethernet cable (RJ45) | 4.5~18 | 1~1.5 / |

Tab. 5-2 PE wire requirements

| Phase cross-section S | wire PE wire cross section | Note |
|------------------------------|----------------------------|---------------------------------|
| $16 < S \leq 35 \text{mm}^2$ | 16 mm ² | The correspondence is available |

| Phase cross-section S | wire | PE wire section | wire cross | Note |
|------------------------|------|-----------------|------------|--|
| S > 35 mm ² | | S/2 | | only when materials of the phase wires and PE wire are the same. If otherwise, ensure that the cross-sectional area of the PE wire produces a conductance equivalent to that of the wire specified in the table. |

5.4 Additional Grounding Connection



WARNING

- Since the inverter is a transformerless inverter, neither the negative pole nor the positive pole of the PV string can be grounded. Otherwise, the inverter will not operate normally.
- Connect the additional grounding terminal to the protective grounding point before AC cable connection, PV cable connection, and communication cable connection.

5.4.1 Additional Grounding Requirements

All non-current carrying metal parts and device enclosures in the PV power system should be grounded, for example, brackets of PV modules and inverter enclosure.

The additional grounding terminal of the single inverter requires near-end grounding.

When there are multiple inverters, additional grounding terminals of all these inverters and grounding points of the PV module brackets should be connected together first and then to an equipotential line, to ensure equipotential connection. Specific operation depends on onsite conditions.

5.4.2 Connection Procedure

Step 1 Prepare the cable and crimp cord end terminal.

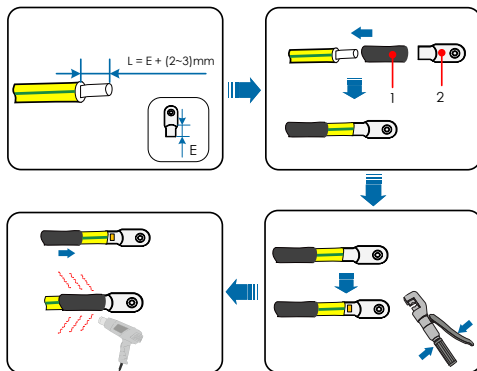

1: Heat shrink tubing

2: Cord end terminal

Step 2 Fasten the cable with a screwdriver.

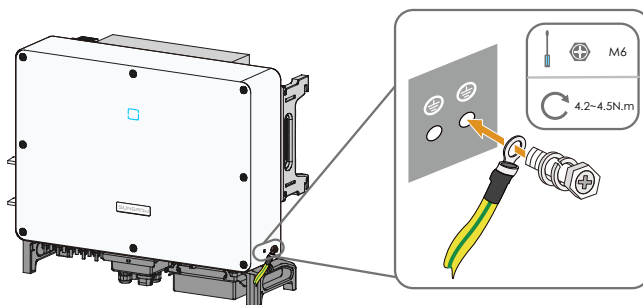

There are two grounding terminals. Use at least one of them to ground the inverter.

5.5 AC Cable Connection

5.5.1 AC Side Requirements

Before connecting the inverter to the grid, ensure the grid voltage and frequency comply with requirements, for which, refer to "10.1 Technical Data". Otherwise, contact the electric power company for help.



Connect the inverter to the grid only after getting an approval from the local electric power company.

AC circuit breaker

An independent four-pole circuit breaker is equipped at the AC side of each inverter to ensure safe disconnection from the grid.

| Inverter | Recommended rated voltage | Recommended rated current |
|----------|---------------------------|---------------------------|
| SG33CX | 400V | 63A |
| SG40CX | | 80A |
| SG50CX | | 100A |

If multiple inverters need to share a circuit breaker, the circuit breaker should be selected according to the capacity.

NOTICE

Never connect a load between the inverter and the circuit breaker.

Requirements for multi-inverter parallel connection

If multiple inverters are connected in parallel to the grid, ensure that the total number of parallel inverters does not exceed 30. Otherwise, please contact SUNGROW for technical scheme.

MV transformer

The MV transformer used together with the inverter should meet the following requirements:

- The transformer may be a distribution transformer, and it must be designed for the typical cyclical loads of a PV system (load in the day and no load at night).
- The transformer may be of the liquid-immersed type or dry type, and shield winding is not necessary.
- The line-to-line voltage on the LV side of the transformer should endure the output voltage of inverter. When connecting to the IT grid, to-ground withstanding voltage of the LV winding of the transformer, the AC cables, and the secondary devices (including the relay protection device, detection & measuring device, and other related auxiliary devices) should not be lower than 1,100V.
- The line-to-line voltage on the HV side of transformer should comply with local power grid voltage.

- A transformer with a tap changer on the HV side is recommended in order to keep consistent with the grid voltage.
- At an ambient temperature of 45°C, the transformer can run in 1.1 times of load for long time.
- Transformer with a short-circuit impedance 6% (permissible tolerance: $\pm 10\%$) is recommended.
- The system cable voltage drop is no more than 3%.
- The DC component that the transformer can withstand is 1% of the fundamental current at rated power.
- For thermal rating, the load curve of the transformer and environment conditions should be taken into account.
- The apparent power of the inverter should never exceed the power of the transformer. The maximum AC current of all inverters connected in parallel must be taken into account. If more than 30 inverters are connected to the grid, contact SUNGROW.
- The transformer must be protected against overloading and short circuit.
- The transformer is an important part of grid-connected PV generation system. The fault tolerance capacity of the transformer should be taken into account at all times. The fault include: system short circuit, grounding fault, voltage drop, etc.
- Take ambient temperature, relative humidity, altitude, air quality, and other environmental conditions into account when selecting and installing the transformer.

5.5.2 Cold Press Terminal Requirements

- Specification: M8, select the specific model according to the size of the AC terminal block.

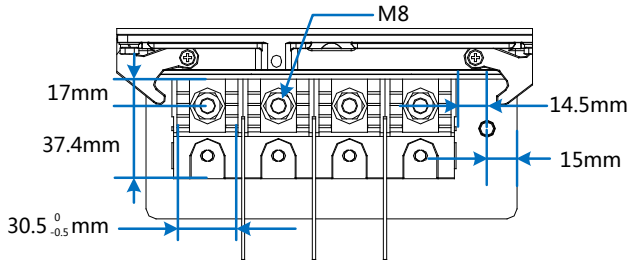

Fig. 5-2 AC terminal block size

- Has good tensile stress.

5.5.3 Aluminium Cable Requirements

If an aluminium cable is selected, use a copper to aluminium adapter terminal to avoid direct contact between the copper bar and the aluminium cable.

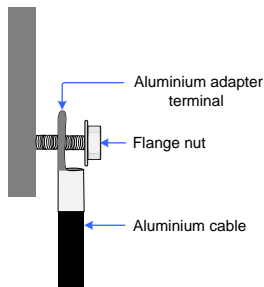

Fig. 5-3 Aluminium cable terminal connection sequence

NOTICE

Direct contact between the copper bar and the aluminium cable will cause electrochemical corrosion and impair the reliability of electrical connection.

5.5.4 Connection Procedure

Step 1 Disconnect the AC-side circuit breaker and prevent it from inadvertent reconnection.

Step 2 Take out the AC junction box and loosen the swivel nut. Remove the seals and select an appropriate one according to cable outer diameter. Lead the cable through the swivel nut, seal, and junction box successively.

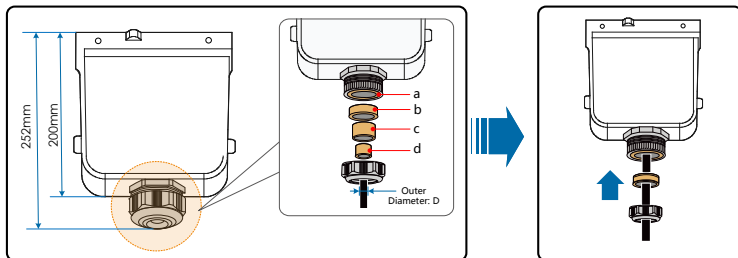

| Outer diameter D(mm) | Seals |
|----------------------|---------|
| 20~25 | a+b+c+d |
| 25~30 | a+b+c |
| 30~40 | a+b |
| 40~50 | a |

Step 3 Strip the protection layer and insulation layer by specific length, as described in the figure below.

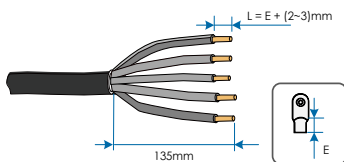

Step 4 Prepare the cable and crimp OT terminal.

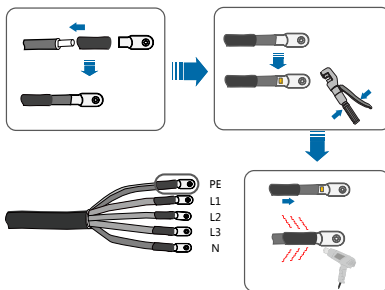

Step 5 Unfasten the buckle and remove the protective cap.

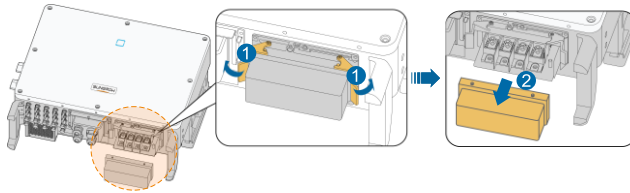

Step 6 Secure the cable to corresponding terminals.

NOTICE

Note the terminal positions of PE wire and N wire. If a phase wire is connected to the PE terminal or N terminal, unrecoverable damage may be caused to the inverter.

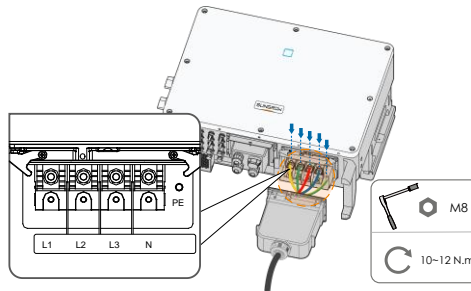

Step 7 Secure the junction box, fasten the buckle, and secure it with supplied M4×10 screw.

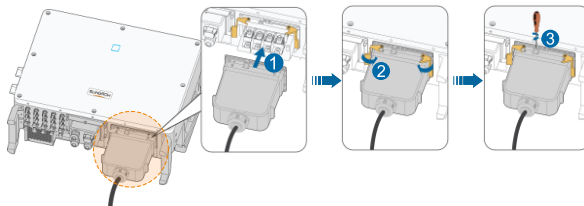

Step 8 Gently pull the cable backwards to ensure firm connection, and fasten the swivel nut clockwise.

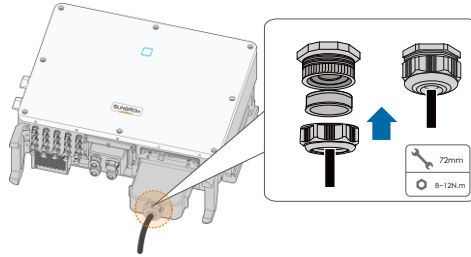

5.6 PV String Connection

⚠ DANGER

Electric shock!

The PV array will generate lethal high voltage once exposed to sunlight.

⚠ WARNING

Make sure the PV array is well insulated to ground before connecting it to the inverter.

NOTICE

There is a risk of inverter damage! The following requirements should be met. Failure to do so will void guarantee and warranty claims.

- **Make sure the voltage of each string does not exceed 1,100V at all times.**
- **Make sure the maximum short circuit current on the DC side is within the permissible range.**
- **Make sure the to-ground insulation performance of the PV string is sound.**

5.6.1 PV Input Configuration

There are multiple inputs of PV strings, and each two has an independent MPPT. Therefore, PV inputs may be different from each other in PV module type, PV module number, angle of tilt, and orientation, as shown in the figure below.

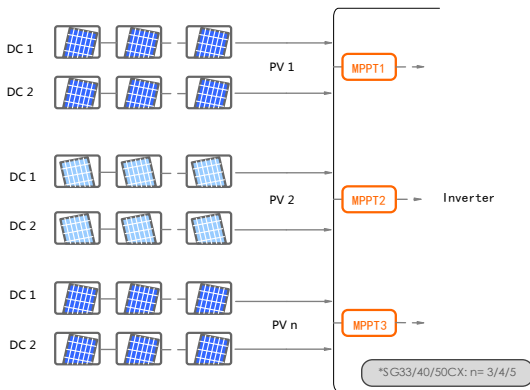

NOTICE

To make the best use of PV input power, PV string structure of the same input should be the same in PV module type, PV module number, angle of tilt, and orientation.

| Type | Open circuit voltage limit | Max. current for input connector |
|--------|----------------------------|----------------------------------|
| SG33CX | 1,100V | 30A |
| SG40CX | 1,100V | 30A |
| SG50CX | 1,100V | 30A |

The PV input needs to be connected via a plug-in PV input terminal which is included in the scope of delivery.

DC cable on the PV string side should be connected via the PV connector which is included in the scope of delivery.



To ensure IP66 protection, use only the connector within the scope of delivery or the connector with the same ingress of protection.

5.6.2 Connection Procedure

DANGER

High voltage may be present in the inverter!

- Ensure all cables are voltage-free before performing electrical operations.
- Do not connect the AC circuit breaker before finishing electrical connection.

NOTICE

Use the MC4 DC terminal within the scope of delivery. Damage to the device due to the use of incompatible terminal shall not be covered by the warranty.

Step 1 Strip insulation layers of all DC cables by about 7mm.

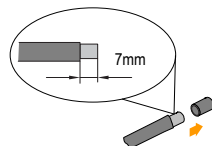

Step 2 Assemble the cable ends with the crimping pliers.

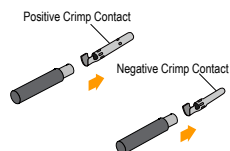

Step 3 Lead the cable through cable gland, and insert into the insulator until it snaps into place. Gently pull the cable backward to ensure firm connection. Tighten the cable gland and the insulator (torque 2.5 N·m to 3 N·m).

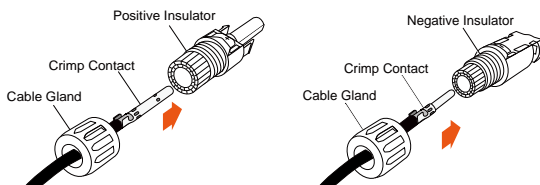

5.6.3 Installing the PV Connectors

Step 1 Rotate the DC switch to "OFF" position.

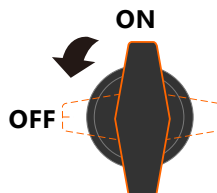

Step 2 Check the cable connection of the PV string for polarity correctness and ensure that the open circuit voltage in any case does not exceed the inverter input limit of 1,100V.

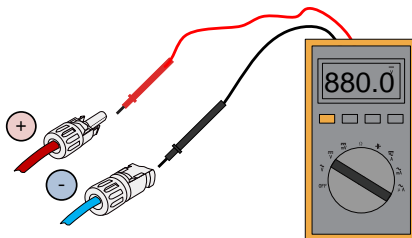

Step 3 Insert the PV connectors to the corresponding terminals until there is an audible click.

NOTICE

Check the positive and negative polarity of the PV strings, and insert the PV connectors to the corresponding terminal only after ensuring polarity correctness.

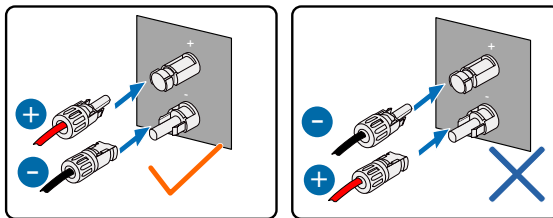

Arc or contactor over-temperature may occur if the PV connectors are not firmly in place, and damage caused shall not be covered by the warranty.

Step 4 Follow the foregoing steps to connect PV connectors of other PV strings.

Step 5 Seal the unused PV terminals with MC4 terminal caps.

5.7 Communication Junction Box

5.7.1 Remove the Junction Box

Step 1 Pull out the pin, and remove the junction box.

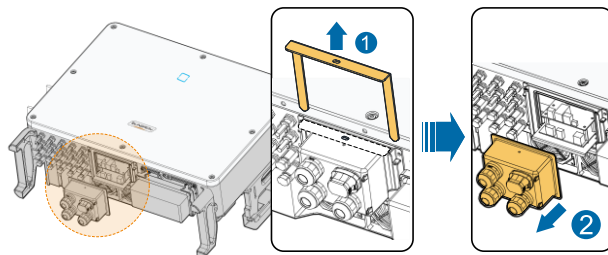

5.7.2 Install the Junction Box

Step 1 Remount the wiring box and press it tightly, insert the pin, and secure the wiring box with the supplied M4×25 screw.

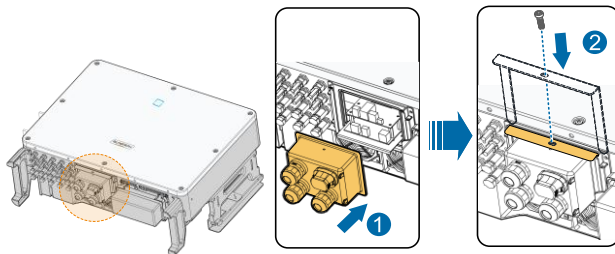

During installation, press the junction box forcibly to ensure that the pin can be inserted successfully.

5.8 Communication Wiring Board

The communication board of the inverter includes two layers. The upper layer communication board mainly includes RS485 communication interfaces while the lower layer communication board mainly includes DI/DO interface and DRM interface.

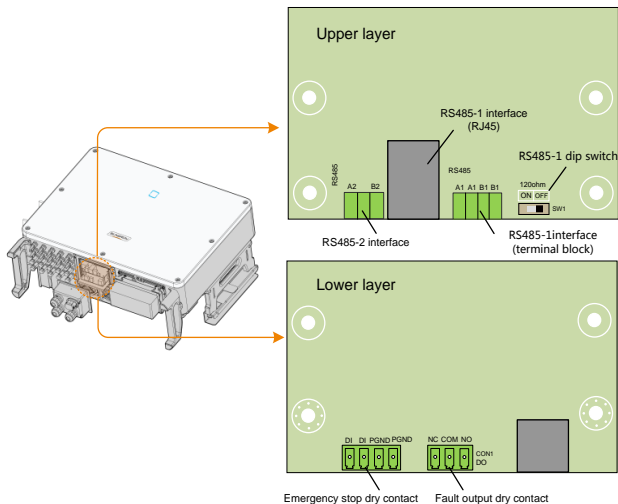

5.9 RS485 Communication

5.9.1 Interface Description

As shown in the figure below, the inverter is equipped with three RS485 communication interfaces and one dip switch.

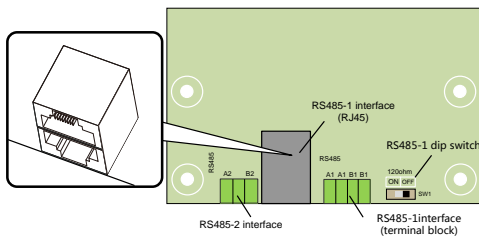

All the three interfaces can be connected to a data acquisition device (Logger), to achieve data exchange with PC or other monitoring devices.

The RS485-2 interface can only be applied to the application scenario of single inverter communication.

The RS485-1 terminal block and the RJ45 interface can be applied to applications where multiple inverters communicate in a daisy-chain form.

A 120Ω resistor can be connected in parallel between RS485-1 A/B pins by configuring the dip switch.



RS485-1 terminal block interface and RJ45 interface serve as the same function with wiring manner different.

5.9.2 RS485 Communication System

Single-inverter communication system

In case of a single inverter, communication cable connection requires only one RS485 cable.

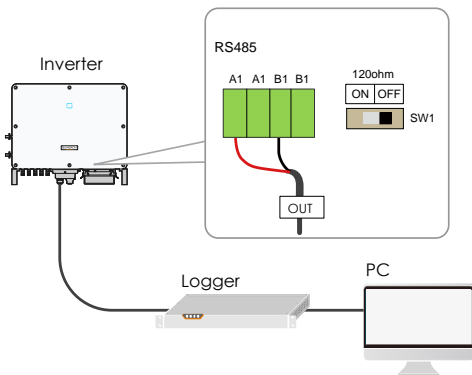

Multi-inverter communication system

In case of multiple inverters, all the inverters can be connected via RS485 cables in the daisy chain manner.

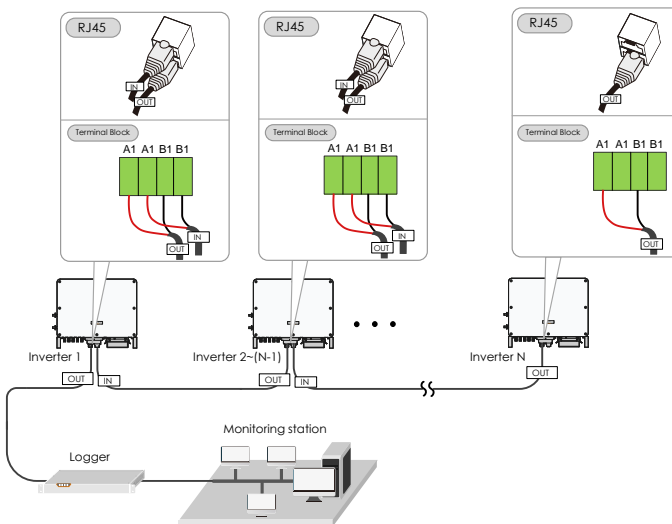

- The length of the RS485 cable should be no longer than 1,200m.
- If multiple inverters are connected to the data acquisition device Logger3000, the number of permissible daisy chains and the number of devices allowed to be connected should meet the requirements (refer to the user manual for the Logger3000).



When more than 15 inverters are connected on the same daisy chain, the inverters on two ends of the chain should be equipped with terminal resistors of 120Ω to ensure communication quality by configuring the dip switch (SW1), and the shielding layer of the communication cable should be single-point grounded.

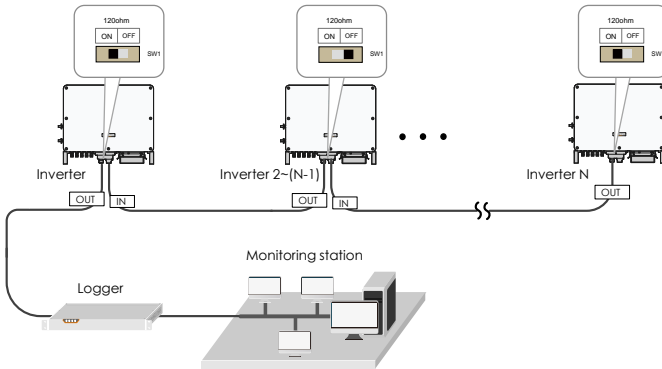

Fig. 5-4 Terminal resistor state

5.9.3 Connection Procedure



- RS485 communication cables should be shielded twisted pair cables or Shielded twisted pair Ethernet cables.
- There are three communication terminals, and the silkscreen marks are COM1/COM3./COM4. Please choose according to the actual situation.

Terminal Block

Step 1 Remove the communication junction box, see 5.7.1 Remove the Junction Box.

Step 2 Loosen the swivel nut of the junction box and select an appropriate seal according to cable outer diameter. Lead the cable through the swivel nut, seal, and junction box successively.

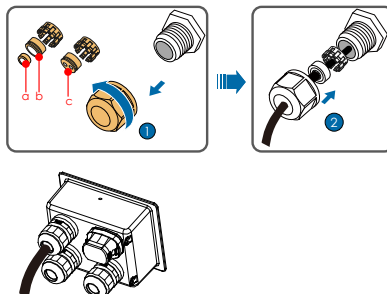

| Outer diameter D(mm) | Seal |
|----------------------|------|
| 4.5~6 | c |
| 6~12 | a+b |
| 13~18 | b |

Step 3 Strip the cable jacket and insulation layer by appropriate length.

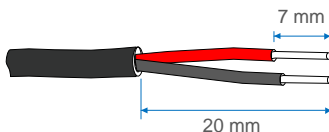

Step 4 Secure the cable to the terminal base.

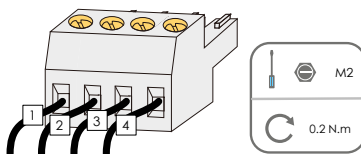

Step 5 Insert the terminal base into the corresponding terminal.

Tab. 5-3 Terminal definition

| No. | Definition |
|-----|---|
| 1 | RS485 A IN, RS485A differential signal+ |
| 2 | RS485 A OUT, RS485A communication signal+ |
| 3 | RS485 B IN, RS485B differential signal- |
| 4 | RS485 B OUT, RS485B communication signal- |

Step 6 If other wiring operations need to be performed on the communication board, finish the wiring operations before performing the following steps. If otherwise, continue to perform the following steps.

Step 7 Install the junction box, see 5.7.2 Install the Junction Box.

Step 8 Pull the cable gently to make sure it is secured, tighten the swivel nut clockwise.

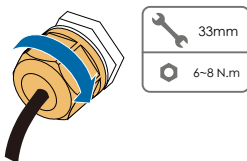

RJ45 network port

Step 1 Remove the communication junction box, see 5.7.1 Remove the Junction Box.

Step 2 Strip the insulation layer of the Ethernet cable with a wire stripper, and insert the signal wires to the RJ45 connector. Crimp the RJ45 connector with a crimping tool.

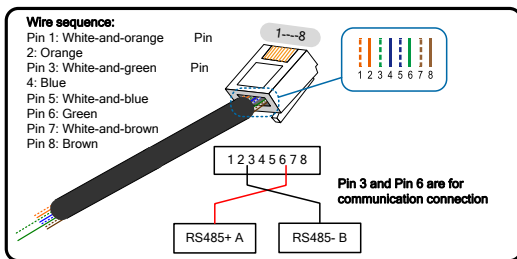

Step 3 Loosen the swivel nut of the junction box and select an appropriate seal according to cable outer diameter. Lead the cable through the swivel nut, seal, and junction box successively.

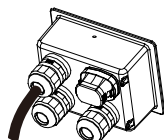
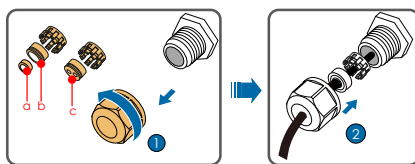

| Outer diameter D(mm) | Seal |
|----------------------|------|
| 4.5~6 | c |
| 6~12 | a+b |

| Outer diameter D(mm) | Seal |
|----------------------|------|
| 13~18 | b |

Step 4 Insert the RJ45 connector to the RJ45 jack.

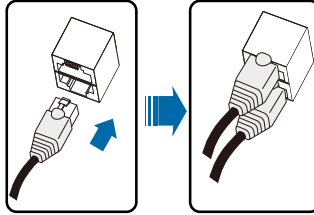

Step 5 If other wiring operations need to be performed on the communication board, finish the wiring operations before performing the following steps. If otherwise, continue to perform the following steps.

Step 6 Install the junction box, see 5.7.2 Install the Junction Box.

Step 7 Pull the cable gently to make sure it is secured, tighten the swivel nut clockwise.

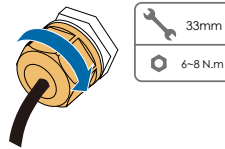

5.10 Dry Contact Connection



Dry contact cables require a cross-sectional area of 1 mm² to 1.5 mm².

The connection procedure of the dry contact is the same as that of the RS485 terminal block.

The configuration circuit board is provided with fault output dry contact and emergency stop dry contact, as shown in the figure below.

Connection method of the dry contacts is similar to that of the RS485 terminal block.

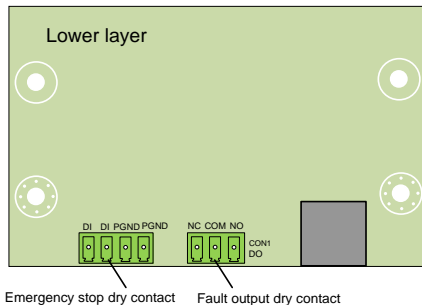

DO terminal (fault output dry contact): the relay can be set to fault alarm output, and user can configure it to be a normal open contact (COM&NO) or a normal close contact (COM&NC).

The relay is initially at the NC terminal, and it will trip to another contact when a fault occurs.

Use LED indicators or other equipment to indicate whether the inverter is in the faulty state. The following figures show the typical applications of normal open contact and normal close contact:

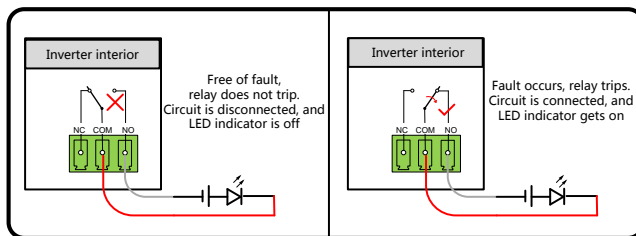

Fig. 5-5 Normal open contact

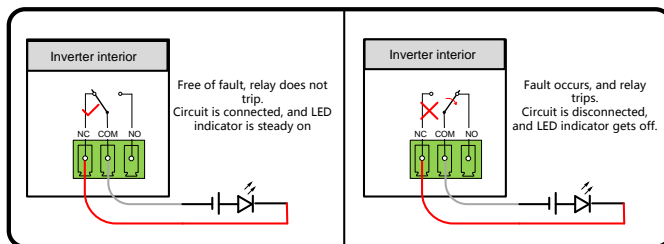

Fig. 5-6 Normal close contact

Devices connected to the relay should comply with related requirements:

| AC-Side Requirements | DC-Side Requirements |
|----------------------|----------------------|
| Max. voltage: 250Vac | Max. voltage: 30Vdc |
| Max. current: 5A | Max. current: 5A |

DI terminal (emergency stop dry contact): the dry contact can be configured to be an emergency stop contact.

When the DI contact and GND contact are shorted by external controlled switch, the inverter will immediately stop.



The dry contacts only support passive switch signal input.

The following figure shows the typical application of local stop dry contact.

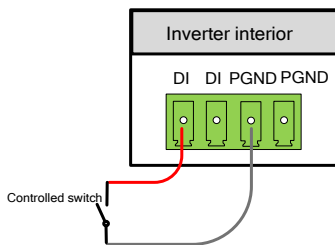

Fig. 5-7 Local stop contact

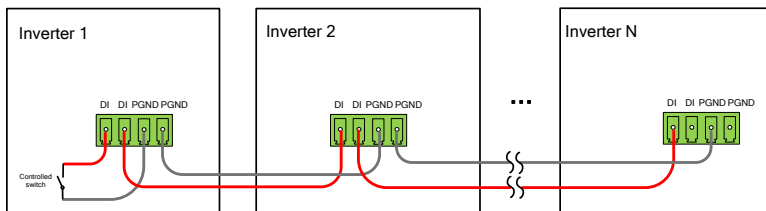

Fig. 5-8 Daisy chain topology

RS485 daisy chain in the master-slave mode

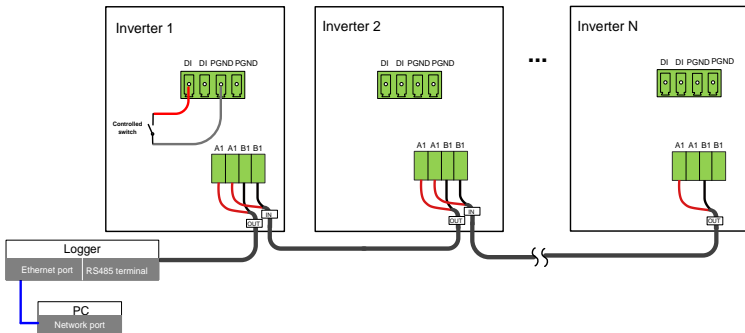

Fig. 5-9 Master-slave mode



The inverter directly connected to the Logger is set to be the master inverter by default, and it sends stop instruction to other inverters via RS485 communication.

NOTICE

Ensure that the impedance at the input node is less than 380Ω.

5.11 Communication Module Connection (optional)

Connect the communication module produced by Sungrow, such as Eye series, WiFi, or E-Net to the communication accessory port. After successful connection, information such as power generation and running state of the inverter can be viewed via the APP on the phone.

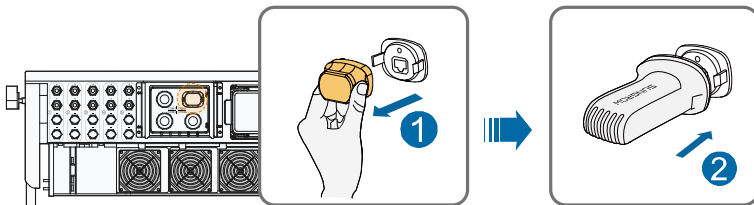

*The image shown here is for reference only. The actual product you receive may differ.

NOTICE

The communication module and the RS485 communication are not available at the same time. Otherwise, communication failure or other problems can be caused.



For details on module installation and configuration, refer to the manual delivered together with the module.

6 Commission

6.1 Inspection before Commissioning

Check the following items before starting the inverter:

- The inverter DC switch and external circuit breaker are disconnected.
- The inverter should be accessible for operation, maintenance and service.
- Nothing is left on the top of the inverter or battery pack.
- The inverter is correctly connected to the external devices, and the cables are routed in a safe place or protected against mechanical damage.
- The selection of the AC circuit breaker is in accordance with this manual and all applicable local standards.
- All unused terminals at the bottom of the inverter are properly sealed.
- Warning signs & labels are suitably affixed and durable.

6.2 Commissioning Procedure

If all of the items mentioned above meet the requirements, proceed as follows to start up the inverter for the first time.

Step 1 Rotate the DC switch of the inverter to "ON" position.

Step 2 Connect the AC switch (if applicable) between the inverter and the grid.

Step 3 Connect the DC switch (if applicable) between the inverter and the PV string.

Step 4 Set initial protection parameters via the iSolarCloud APP. For details, please refer to "7.4.2 Login Steps". If the irradiation and grid conditions meet requirements, the inverter will normally operate.

Step 5 Observe the LED indicator to ensure that the inverter operates normally. (Refer to Tab. 2-2LED indicator description).

7 iSolarCloud APP

7.1 Brief Introduction

The iSolarCloud APP can establish communication connection to the inverter via the Bluetooth, thereby achieving near-end maintenance on the inverter. Users can use the APP to view basic information, alarms, and events, set parameters, or download logs, etc.

*In case the communication module Eye or WiFi is available, the iSolarCloud APP can also establish communication connection to the inverter via the mobile data or WiFi, thereby achieving remote maintenance on the inverter.



- This manual describes only how to achieve near-end maintenance via the Bluetooth connection. For remote maintenance through the Eye or WiFi, refer to the related manuals in the delivery scope.
- Screenshots in this manual are based on the Android system V2.1.4, and the actual interfaces may differ.

7.2 Download and Install

Method 1

Download and install the APP through the following application stores:

- MyApp (Android, mainland China users)
- Google Play (Android, users other than mainland China ones)
- APP store (iOS)

Method 2

Scan the following QR code to download and install the APP according to the prompt information.



The APP icon appears on the home screen after installation.



iSolarCloud

7.3 Menu

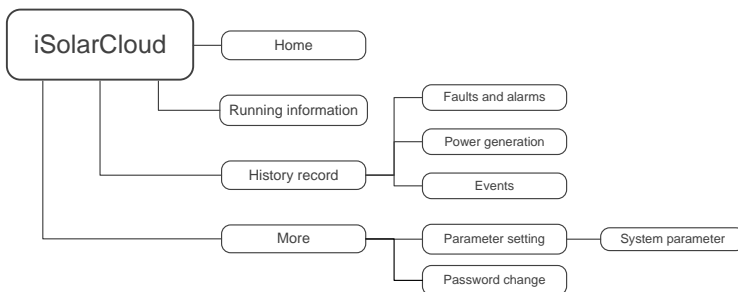

Fig. 7-1 Menu tree

7.4 Login

7.4.1 Requirements

The following items should meet requirements:

- The AC and DC sides or the AC side of the inverter is powered-on.

- The mobile phone is within 5m away from the inverter and there are no obstructions in between.
- The Bluetooth function of the mobile phone is enabled.

7.4.2 Login Steps

Step 1 Open the APP to enter the login interface, and click "Direct Login" to enter the next screen.

Step 2 Open the APP, after which the Bluetooth search screen pops up automatically, and select the to-be-connected inverter according the SN on the nameplate of the inverter. The Bluetooth indicator gets on once the connection is established. Alternatively, tap "📄" to scan the QR code on the side of the inverter to establish Bluetooth connection.

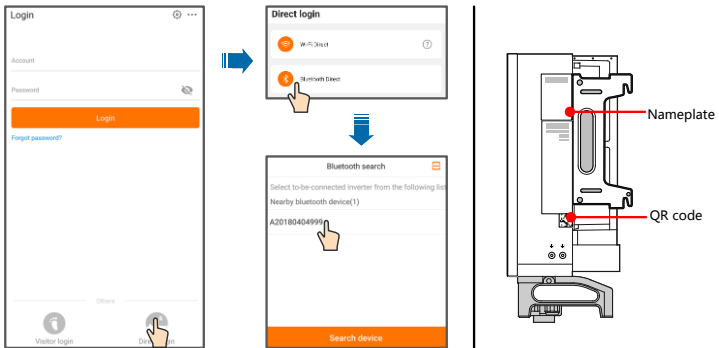

Fig. 7-2 Bluetooth connection

Step 3 Enter the login screen after the Bluetooth connection is established.

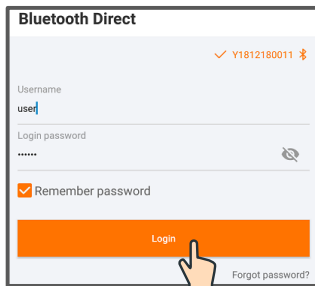

Fig. 7-3 Login



- The username is "user", the initial password is "pw1111" which should be changed for the consideration of account security.
- To set inverter parameters related to grid protection and grid support, contact SUNGROW to obtain the advanced account and corresponding password.

Step 4 If the inverter is not initialized, you will enter the quick setting screen of initialize protection parameter. After finishing setting on the quick setting screen, click "Boot" and the device will be initialized. The APP will send start instructions and the device will start and operate.

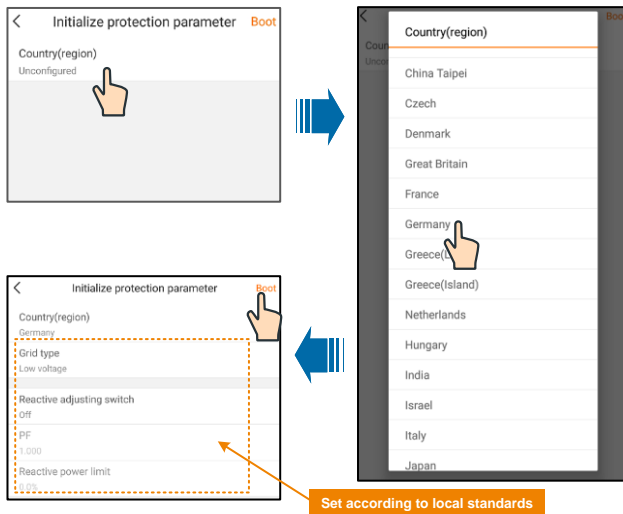

Fig. 7-4 Initialization protection parameter

NOTICE

Reset the protection parameters if the country setting is incorrect. Otherwise, fault may occur.

Step 5 If the inverter is initialized, the APP automatically turns to its home page.

7.5 Home page

After login, the home page is as follows:

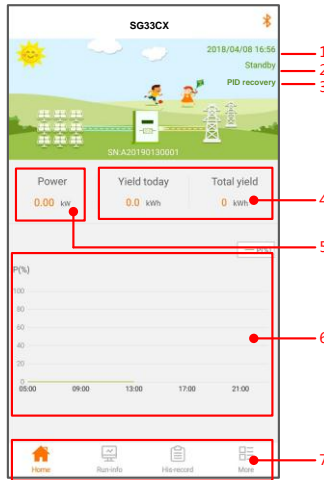

Fig. 7-5 Home page

Tab. 7-1 Home page description

| No. | Designation | Description |
|-----|--------------------|--|
| 1 | Date and time | System date and time of the inverter |
| 2 | Inverter state | Present operation state of the inverter For details, refer to Tab. 7-2Description of inverter state |
| 3 | PID function state | Present state of the PID function For details, refer to Tab. 7-3Description of PID function state |
| 4 | Power generation | Today power yield and accumulative power yield of the inverter |
| 5 | Real-time power | Output power of the inverter |
| 6 | Power curve | Curve showing change of power between 5 am and 23 pm every day (Each point on the curve represents the percentage of present inverter power to rated power) |
| 7 | Navigation bar | Including "Home", "Run-info", "His-record", and "More" |

Tab. 7-2 Description of inverter state

| State | Description |
|-------|---|
| Run | After being energized, inverter tracks the PV arrays' maximum power point (MPP) and converts the DC power into AC power. This is the normal operation mode. |
| Stop | Inverter is stopped. |

| State | Description |
|--------------------|---|
| Key-stop | Inverter will stop operation by manually “stop” via app. In this way, inverter internal DSP stops. To restart the inverter, manually start via app. |
| Standby | Inverter enters standby mode when DC side input is insufficient. In this mode inverter will wait within the standby duration. |
| Initial standby | The inverter is in the initial power-on standby state |
| Starting | The inverter is initializing and synchronizing with the grid. |
| Warning | Warning information is detected. |
| Derating running | The inverter derates actively due to environmental factors such as temperature or altitude |
| Scheduling running | The inverter runs according to the scheduling instructions received from the monitoring background |
| Fault | If a fault occurs, inverter will automatically stop operation, and disconnect the AC relay. The fault information will be displayed in the app. Once the fault is removed in recovery time, inverter will automatically resume running. |

Tab. 7-3 Description of PID function state

| State | Description |
|----------------------|--|
| PID recovery running | The inverters perform PID recovery actively. |
| PID abnormality | It is detected that the ISO impedance is abnormal or the PID function cannot work normally after the PID function enabled. |
| PID standby | The PID function is enabled, but regulation is not performed actually and no abnormality is detected. |

If the inverter is running abnormally, the alarm or fault icon will be displayed in the lower right corner of the inverter icon in the middle of the screen. The user can tap this icon to enter the alarm or fault screen to view detailed information and corrective measures.

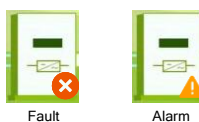

7.6 Running Information

Tap "Run info" on the navigation bar to enter the running information screen, as shown in the following figure.

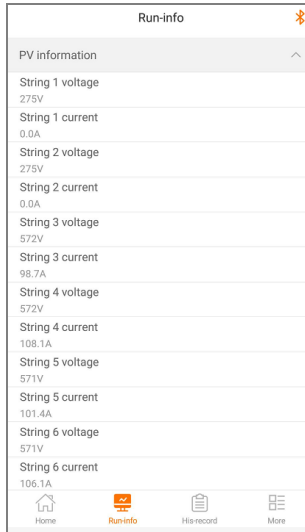

Fig. 7-6 Running Information

The run info includes the input, output, string, grid voltage, grid current, environment, and other information.

Tab. 7-4 Run info

| Parameter | Description | Parameter |
|---------------------|----------------------------------|---|
| Input | Total DC power (kW) | Input |
| | PV x voltage (V) | The input voltage of the x th string |
| | PV x current (A) | The input current of the x th string |
| Output | AC frequency (Hz) | Output |
| | Total active power (kW) | |
| | Apparent power(kVA) | |
| Grid voltage | Monthly generating capacity(kWh) | The energy generated in this month |
| | A phase voltage (V) | Grid voltage |
| | B phase voltage (V) | |
| C phase voltage (V) | | |
| Grid current | A phase current (V) | Grid current |
| | B phase current (A) | |
| | C phase current (A) | |
| Environment | Inner temperature (°C) | Environment |

| Parameter | Description | Parameter |
|-----------|---------------------------------------|---------------------------------------|
| Other | In parallel resistance to ground (kΩ) | Other |
| | Countries info | Inverter selected country code |
| | Command info | Inverter selected command information |

7.7 History Record

Tap "His-record" on the navigation bar to enter the history record screen, as shown in the following figure.

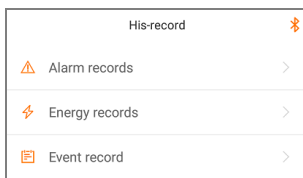

Fig. 7-7 History record

On "history record" screen, users can check the alarm records, power yield records and event records.

7.7.1 Fault Alarm Records

Tap " Alarm records " to view fault and alarm records, as shown in the following figure.

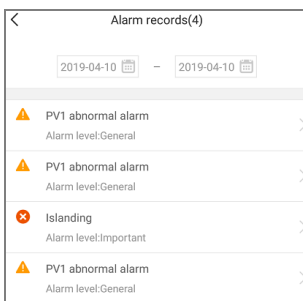

Fig. 7-8 Fault and alarm records



- Click "📅" to select a time segment and view corresponding records.
- The inverter can record up to 400 latest entries.

Select one of the records in the list and click the record, to view the detailed fault info as shown in following figure.

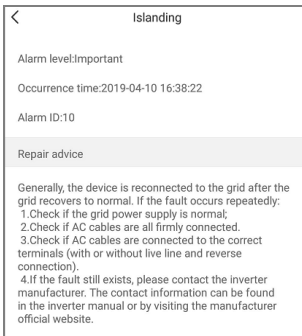

Fig. 7-9 Detailed fault alarm info

7.7.2 Power Yields Records

User can view various energy records: power curve, daily energy histogram, daily energy histogram, monthly energy histogram, and annual energy histogram.

Tab. 7-5 Explanation of power yields records

| Parameter | Description |
|--------------------------|---|
| Power curve | Show the power output from 5 am to 11 pm in a single day. Each point in the curve is the percentage of present power and nominal power. |
| Daily energy histogram | Shows the power output every day in the present month. |
| Monthly energy histogram | Shows the power output every month in a year. |
| Annual energy histogram | Shows the power output every year. |

Click the “🔗 Energy records” to view the power curve page as shown in following figure.

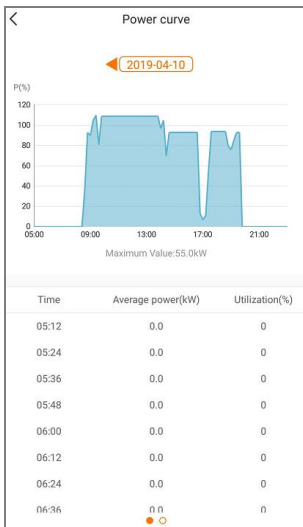

Fig. 7-10 Power curve

Tap the time bar on the top of the screen to select a time segment and view the corresponding power curve.

Step 2 Swipe left to check the power yields histogram

7.7.3 Event Records

Click " Event record" to view event record list.



- Click "" to select a time segment and view corresponding event records.
- The inverter can at most record the latest 400 events

7.8 More

Tap " More" on the navigation bar to enter the "More" screen, as shown in the following figure.

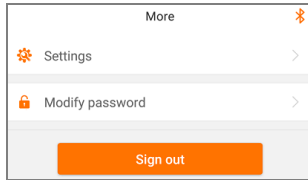



Fig. 7-11 More

7.8.1 Parameter Setting

Tap "  Settings" to enter the parameter setting screen, as shown in the following figure.

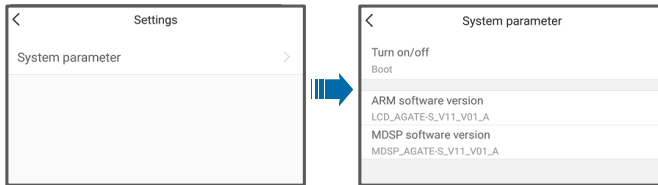



Fig. 7-12 Parameter setting

Tap " **System parameter**" to enter the system parameter screen on which start/stop instruction can be sent to the inverter and information such as ARM version and MDSP version can be viewed.

7.8.2 Password Changing

Tap "  Modify password" to enter the modify password screen, as shown in the following figure.

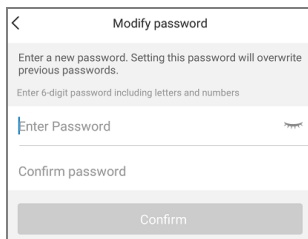

Fig. 7-13 Change password

The new password should consist of 6 characters, a combination of letters and digits.

8 System Decommissioning

8.1 Disconnecting the Inverter

For maintenance or other service work, the inverter must be switched off.

Proceed as follows to disconnect the inverter from the AC and DC power sources. Lethal voltages or damage to the inverter will follow if otherwise.

- Step 1** Disconnect the external AC circuit breaker or disconnect to prevent it from accidentally reconnecting to the utility grid.
- Step 2** Rotate the DC switch to the "OFF" position for disconnecting all of the PV string inputs
- Step 3** Wait about 5 minutes until the capacitors inside the inverter have been discharged.
- Step 4** Ensure that the DC cable is current-free via a current clamp.
- Step 5** Insert a MC4 wrench into the notch and press the wrench with an appropriate force to remove the DC connector.

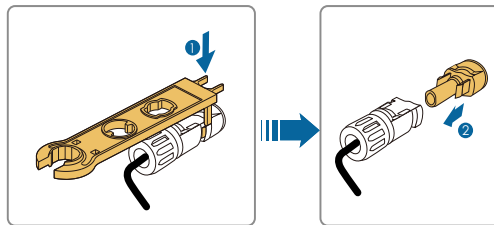

- Step 6** Remove the AC junction box, ensure that the AC wiring terminals are voltage-free via a multimeter, and remove the AC wires.
- Step 7** Install the MC4 waterproof plugs and AC waterproof cover.



For further disconnection and reconnection instructions, please visit the webpage of respective component manufacturer.

8.2 Dismantling the Inverter

Refer to Chapter 5 and Chapter 6 to dismantle the inverter in reverse steps.

⚠ CAUTION

Risk of burn injuries and electric shock!

Do not touch any inner live parts until at least 5 minutes after disconnecting the inverter from the utility grid and the PV input.

NOTICE

If the inverter will be reinstalled in the future, please refer to "3.4 Inverter Storage" for a proper storage.

8.3 Disposal of the Inverter

Users take the responsibility for the disposal of the inverter.

NOTICE

Some parts and devices of the inverter, such as the capacitors, may cause environmental pollution.

Do not dispose of the product together with household waste but in accordance with the disposal regulations for electronic waste applicable at the installation site.

9 Troubleshooting and Maintenance

9.1 Troubleshooting

Once a fault occurs in the inverter, the fault information can be displayed on the APP interface.

Fault codes and check methods are as follows:

| Fault code | Description | Check method |
|------------|--|--|
| 002 | Grid overvoltage, The grid voltage is higher than the set protection value. | Generally, the inverter will be reconnected to the grid after the grid returns to normal. If the fault occurs repeatedly: 1. Measure the actual grid voltage, and contact the local electric power company for solutions if the grid voltage is higher than the set value. 2. Check whether the protection parameters are appropriately set via the APP or the LCD. 3. Check whether the cross-sectional area of the AC cable meets the requirement. 4. If the fault is not caused by the foregoing reasons and still exists, contact Sungrow Service. |
| 003 | Transient overvoltage, The transient grid voltage is higher than the standard value. | Generally, the inverter will be reconnected to the grid after the grid returns to normal. If the fault occurs repeatedly, contact Sungrow Service. |

| Fault code | Description | Check method |
|------------|---|--|
| 004-005 | Grid undervoltage, The grid voltage is lower than the set protection value | Generally, the inverter will be reconnected to the grid after the grid returns to normal. If the fault occurs repeatedly: 1. Measure the actual grid voltage, and contact the local electric power company for solutions if the grid voltage is lower than the set value. 2. Check whether the protection parameters are appropriately set via the APP or the LCD. 3. Check whether the AC cable is firmly in place. 4. If the fault is not caused by the foregoing reasons and still exists, contact Sungrow Service. |
| 006-007 | AC output current exceeds the upper limit of the inverter. | Generally, the inverter will be reconnected to the grid after the grid returns to normal. If the fault occurs repeatedly, contact Sungrow Service. |
| 008 | Grid overfrequency, Grid frequency exceeds the upper limit of the inverter. | Generally, the inverter will be reconnected to the grid after the grid returns to normal. If the fault occurs repeatedly: |
| 009 | Grid underfrequency, Grid frequency is lower than the lower limit of the inverter. | 1. Measure the actual grid frequency, and contact the local electric power company for solutions if the grid frequency is beyond the set range. 2. Check whether the protection parameters are appropriately set via the APP or the LCD. 3. If the fault is not caused by the foregoing reasons and still exists, contact Sungrow Service. |

| Fault code | Description | Check method |
|------------|---|---|
| 010 | AC power failure, AC switch or circuit is disconnected. | <p>Generally, the inverter will be reconnected to the grid after the grid returns to normal. If the fault occurs repeatedly:</p> <ol style="list-style-type: none"> 1. Check whether the grid supplies power reliably. 2. Check whether the AC cable is firmly in place. 3. Check whether the AC cable is connected to the correct terminal (whether the live wire and the N wire are correctly in place). 4. Check whether the AC circuit breaker is connected. 5. If the fault is not caused by the foregoing reasons and still exists, contact Sungrow Service. |
| 011 | DC component in the AC current exceeds the permissible range of the inverter. | <ol style="list-style-type: none"> 1. The fault is caused by external fault of the inverter. Generally, the inverter will be reconnected to the grid after the external fault is removed. 2. If the fault occurs repeatedly, contact Sungrow Service. |
| 012 | Excessive current leakage | <ol style="list-style-type: none"> 1. The fault can be caused by poor sunlight or damp environment, and the inverter will be reconnected to the grid after the environment is improved. 2. If the environment is normal, check whether the AC and DC cables are well insulated. 3. If the fault is not caused by the foregoing reasons and still exists, contact Sungrow Service. |
| 013 | The grid voltage or frequency is out of the permissible range, and the inverter cannot be connected to the grid normally. | <p>Generally, the inverter will be reconnected to the grid after the grid returns to normal. If the fault occurs repeatedly:</p> <ol style="list-style-type: none"> 1. Measure the actual grid frequency, and contact the local electric power company for solutions if the grid parameter exceeds the set value. 2. If the fault is not caused by the foregoing reasons and still exists, contact Sungrow Service. |

| Fault code | Description | Check method |
|-------------------|--|--|
| 014 | The grid voltage exceeds the preset AC voltage of the inverter for a long time. | Wait for the inverter to return to normal. If the fault occurs repeatedly, contact Sungrow Service. |
| 015 | Grid overvoltage, The grid voltage is higher than the set protection value | Generally, the inverter will be reconnected to the grid after the grid returns to normal. If the fault occurs repeatedly: 1. Measure the actual grid voltage, and contact the local electric power company for solutions if the grid voltage is higher than the set value. 2. Check whether the protection parameters are appropriately set via the APP or the LCD. 3. Check whether the cross-sectional area of the AC cable meets the requirement. 4. If the fault is not caused by the foregoing reasons and still exists, contact Sungrow Service. |
| 016 | Output overload, The configured module power is excessively large and out of the normal operation range of the inverter. | Wait for the inverter to return to normal. If the fault still exists, contact Sungrow Service. |
| 017 | The inverter detects unbalanced three-phase grid voltage | Generally, the inverter will be reconnected to the grid after the grid returns to normal. If the fault occurs repeatedly, contact Sungrow Service. |
| 019-020 | Excessively high bus voltage | Generally, the inverter will be reconnected to the grid after the bus voltage returns to normal. If the fault occurs repeatedly: 1. Check the PV voltage via the APP or the LCD. If the PV voltage exceeds the maximum permissible voltage, it indicates that the PV module configuration is too high and needs to be optimized. 2. If the fault is not caused by the foregoing reasons and still exists, contact Sungrow Service. |

| Fault code | Description | Check method |
|--------------------|---|--|
| 021-022 | The inverter detects input overcurrent of the modules | Wait for the inverter to return to normal. Disconnect the AC and DC switches, and reconnect the AC and DC switches 15 minutes later to restart the inverter. If the fault still exists, contact Sungrow Service. |
| 024-026 030-034 | Device anomaly | Wait for the inverter to return to normal. Disconnect the AC and DC switches, and reconnect the AC and DC switches 15 minutes later to restart the inverter. If the fault still exists, contact Sungrow Service. |
| 036-037 | Temperature anomaly, The temperature of the power module or the interior of the inverter is excessively high and out of the safe range. | <ol style="list-style-type: none"> 1. Check whether the inverter is directly exposed to sunlight. If so, take some shading measures. 2. Check and clean the air ducts. 3. Check whether there is 070 (fan anomaly) alarm via the APP or the LCD. If so, replace the fans. |
| 038 | Device anomaly | Wait for the inverter to return to normal. Disconnect the AC and DC switches, and reconnect the AC and DC switches 15 minutes later to restart the inverter. If the fault still exists, contact Sungrow Service. |
| 039 | Low insulation resistance, which is generally caused by poor insulation to ground of the module/cable or by rainy and damp environment. | <p>Wait for the inverter to return to normal. If the fault occurs repeatedly:</p> <ol style="list-style-type: none"> 1. Check whether the ISO resistance protection value is excessively high via the APP or the LCD, and ensure that it complies with the local regulations. 2. Check the resistance to ground of the string and DC cable. Take correction measures in case of short circuit or damaged insulation layer. 3. If the cable is normal and the fault occurs on rainy days, check it again when the weather turns fine. 4. If the fault is not caused by the foregoing reasons and still exists, contact Sungrow Service. |

| Fault code | Description | Check method |
|--------------------|---|--|
| 040-042 | Device anomaly | Wait for the inverter to return to normal. Disconnect the AC and DC switches, and reconnect the AC and DC switches 15 minutes later to restart the inverter. If the fault still exists, contact Sungrow Service. |
| 043 | The ambient temperature is lower than the temperature at which the inverter can operate normally. | Stop and disconnect the inverter. Restart the inverter when the ambient temperature falls within the operation temperature range. |
| 044-045 | Device anomaly | Wait for the inverter to return to normal. Disconnect the AC and DC switches, and reconnect the AC and DC switches 15 minutes later to restart the inverter. If the fault still exists, contact Sungrow Service. |
| 048-051 053-060 | Device anomaly | Wait for the inverter to return to normal. Disconnect the AC and DC switches, and reconnect the AC and DC switches 15 minutes later to restart the inverter. If the fault still exists, contact Sungrow Service. |
| 070 | Fan fault | 1. Check whether the fans operate normally and are blocked by sundries. If they are blocked, clear the sundries. 2. If a fan does not operate normally, stop and disconnect the inverter to replace the fan. |
| 071 | AC SPD fault | Check the SPD, and replace it if necessary. |
| 072 | DC SPD fault | |
| 073 | Device anomaly | Wait for the inverter to return to normal. Disconnect the AC and DC switches, and reconnect the AC and DC switches 15 minutes later to restart the inverter. If the fault still exists, contact Sungrow Service. |
| 074 | Internal communication anomaly, A fault occurs in the internal communication module of the inverter. | Contact Sungrow Service. |

| Fault code | Description | Check method |
|------------|--|---|
| 075-077 | Device anomaly | Wait for the inverter to return to normal. Disconnect the AC and DC switches, and reconnect the AC and DC switches 15 minutes later to restart the inverter. If the fault still exists, contact Sungrow Service. |
| 078-081 | Device anomaly | Wait for the inverter to return to normal. Disconnect the AC and DC switches, and reconnect the AC and DC switches 15 minutes later to restart the inverter. If the fault still exists, contact Sungrow Service. |
| 087 | AFD module anomaly | 1. Check whether the cable connection on the DC side is normal, and take corrective measures if necessary. |
| 088 | Electric arc fault | |
| 089 | AFD disable alarm | 2. If the fault is not caused by the foregoing reasons and still exists, contact Sungrow Service. |
| 105 | Protection self-check failure on grid side | Restart the inverter or clear the fault through the App. If the fault still exists, contact Sungrow Service. |
| 106 | Grounding anomaly | 1. Check whether the AC cable is correctly connected. 2. Check whether the insulation between the ground cable and the live wire is normal. 3. If the fault is not caused by the foregoing reasons and still exists, contact Sungrow Service. |
| 116-117 | Device anomaly | Wait for the inverter to return to normal. Disconnect the AC and DC switches, and reconnect the AC and DC switches 15 minutes later to restart the inverter. If the fault still exists, contact Sungrow Service. |

| Fault code | Description | Check method |
|------------|-------------------------------|---|
| 532-547 | Reverse string polarity | <p>1. Check whether the corresponding string is of reverse polarity. If so, disconnect the DC switch and adjust the polarity when the solar radiation is low and the string current drops below 1A.</p> <p>2. If the fault is not caused by the foregoing reasons and still exists, contact Sungrow Service.</p> <p>*The code 532 to code 547 are corresponding to string 1 to string 16 respectively.</p> |
| 548-563 | String output current anomaly | <p>1. Check whether the corresponding module is sheltered. If so, remove the shelter and ensure module cleanness.</p> <p>2. Check the module for abnormal aging.</p> <p>3. If the fault is not caused by the foregoing reasons and still exists, contact Sungrow Service.</p> <p>*The code 548 to code 563 are corresponding to string 1 to string 16 respectively.</p> |
| 564-565 | Reverse string polarity | <p>1. Check whether the corresponding string is of reverse polarity. If so, disconnect the DC switch and adjust the polarity when the solar radiation is low and the string current drops below 1A.</p> <p>2. If the fault is not caused by the foregoing reasons and still exists, contact Sungrow Service.</p> <p>*The code 564 and code 565 are corresponding to string 17 and string 18 respectively.</p> |
| 580-581 | String output current anomaly | <p>1. Check whether the corresponding module is sheltered. If so, remove the shelter and ensure module cleanness.</p> <p>2. Check the module for abnormal aging.</p> <p>3. If the fault is not caused by the foregoing reasons and still exists, contact Sungrow Service.</p> <p>*The code 580 and 581 are corresponding to string 17 and string 18 respectively.</p> |

9.2 Maintenance

DANGER

Risk of inverter damage or personal injury due to incorrect service!

Always keep in mind that the inverter is powered by dual sources: PV strings and utility grid.

Before any service work, observe the following procedure.

- **Disconnect the AC circuit breaker and then set the DC load-break switch of the inverter to OFF;**
- **Wait at least 10 minutes for inner capacitors to discharge completely;**
- **Verify that there is no voltage or current before pulling any connector.**

CAUTION

Keep non-related persons away!

A temporary warning sign or barrier must be posted to keep non-related persons away while performing electrical connection and service work.

NOTICE

Risk of inverter damage if it is improperly serviced.

Use accessories and spare parts approved by the inverter manufacturer only. Never modify the inverter or other components of the inverter.

Unauthorized alterations will void guarantee and warranty claims and in most cases terminate the operating license. SUNGROW shall not be held liable for any damage caused by such changes.

NOTICE

Any malfunction that may impair the inverter safety operation must be repaired immediately before the inverter is restarted.

Inverter contains no customer serviceable parts inside. Please contact local authorized personnel if any service work is required.

9.2.1 Routine Maintenance

| Item | Method | Period |
|-----------------------|--|--|
| System clean | Check the temperature and dust of the inverter. Clean the inverter enclosure if necessary. Check if the air inlet and outlet are normal. Clean the air inlet and outlet, if necessary. | Six months to a year (depend on the dust contents in air.) |
| Fans | Check whether there is fan warning using APP. Check whether there is any abnormal noise when the fan is turning. Clean or replace the fans if necessary (see the following section). | Once a year |
| Cable entry | Check whether the cable entry is insufficiently sealed or the gap is excessively large, and reseal the entry when necessary. | Once a year |
| Electrical Connection | Check whether all cable are firmly in place. Check whether a cable is damaged, especially the part contacting the metal enclosure. | Six months to a year |

9.2.2 Maintenance Instruction

Fan Maintenance

Fans inside the inverter are used to cool the inverter during operation. If the fans do not operate normally, the inverter may not be cooled down and inverter efficiency may decrease. Therefore, it is necessary to clean the dirty fans and replace the broken fans in time.

DANGER

- **Stop the inverter and disconnect it from all power supplies before maintenance.**
- **Lethal voltage still exists in the inverter. Please wait for at least 5 minutes and then perform maintenance work.**
- **Only qualified electricians can maintain the fans.**

The operation procedure is as follows:

Step 1 Stop the inverter (see 8.1 Disconnecting the Inverter).

Step 2 Loosen the screw on the sealing plate of the fan module.

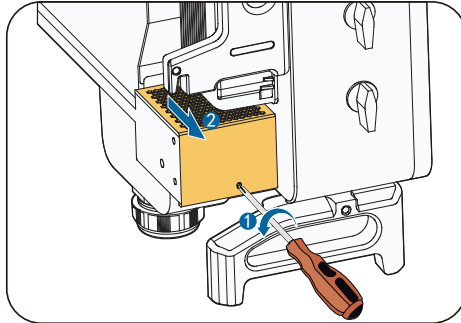

Step 3 Press the hump of the latch hook, unplug the cable connection joint outwards, and loosen the screw on the fan holder.

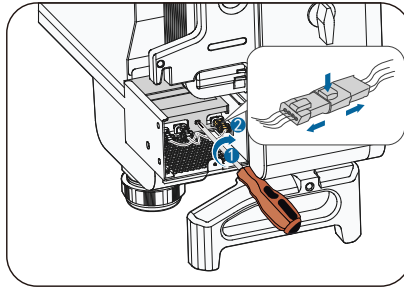

Step 4 Pull out the fan module, clean the fans with soft brush or vacuum cleaner, and replace them when necessary.

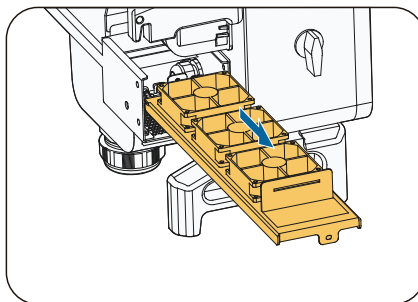

Step 5 Reinstall the fan back to the inverter in reverse order and restart the inverter.

Cleaning Air Inlet and Outlet

A huge amount of heat is generated in the process of running the inverter. The

inverter adopts a controlled forced-air cooling method.

In order to maintain good ventilation, please check to make sure the air inlet and outlet are not blocked.

Clean the air inlet and outlet with soft brush or vacuum cleaner if necessary.

10 Appendix

10.1 Technical Data

| Parameters | SG33CX | SG40CX | SG50CX |
|---|---------------------------------|--------|--------|
| Input (DC) | | | |
| Max. PV input voltage | 1100V | | |
| Min.PV input voltage/Startup input voltage | 200V / 250V | | |
| Nominal input voltage | 585V | | |
| MPP voltage range | 200~1000V | | |
| MPP voltage range for nominal power | 550~850V | | |
| No. of independent MPP inputs | 3 | 4 | 5 |
| Max. number of PV strings per MPPT | 2 | | |
| Max. PV input current | 78A | 104A | 130A |
| Max. current for input connector | 30A | | |
| Max.DC Short-circuit current | 120A | 160A | 200A |
| Max. inverter backfeed current to the array | 0A | | |
| Output (AC) | | | |
| AC output power @ 40 °C | 36.3 kVA | 44 kVA | 55 kVA |
| AC output power @ 45 °C | 33 kVA | 40 kVA | 50 kVA |
| Max. AC output current | 55.2A | 66.9A | 83.6A |
| Nominal AC voltage | 3 / N / PE , 230 / 400V | | |
| AC voltage range | 312~528V | | |
| Nominal grid frequency/Grid frequency range | 50Hz / 45~55Hz , 60Hz / 55~65Hz | | |
| Total harmonic distortion (THD) | < 3 % (at nominal power) | | |
| DC current injection | <0.5%In | | |
| Power factor | >0.99 | | |
| Adjustable power factor | 0.8 leading – 0.8 lagging | | |

| Parameters | SG33CX | SG40CX | SG50CX |
|--|--|-------------------|-------------------|
| Feed-in phases / Connection phases | 3/3 | | |
| Efficiency | | | |
| Max. efficiency / European efficiency | 98.6% / 98.3% | 98.6% / 98.3% | 98.7% / 98.4% |
| Protection | | | |
| DC reverse connection protection | Yes | | |
| AC short-circuit protection | Yes | | |
| Leakage current protection | Yes | | |
| Grid monitoring | Yes | | |
| DC switch / AC switch | Yes / No | | |
| PV string current monitoring | Yes | | |
| Q at night | Yes | | |
| PID recovery function | Optional | | |
| Overvoltage protection | DC Type II / AC Type II | | |
| General Data | | | |
| Dimensions (W*H*D) | 702 × 595 × 310mm | 782 × 645 × 310mm | 782 × 645 × 310mm |
| Weight | 50kg | 58kg | 62kg |
| Isolation method | Transformerless | | |
| Degree of protection | IP66 | | |
| Night power consumption | ≤2 W | | |
| Operating ambient temperature range | -30 to 60 °C (> 45 °C derating) | | |
| Allowable relative humidity (non-condensing) range | 0 - 100% | | |
| Cooling method | Smart forced air cooling | | |
| Max. operating altitude | 4000 m (> 3000 m derating) | | |
| Display | LED, Bluetooth + APP | | |
| Communication | RS485/ Wi-Fi(optional)/Ethernet(optional) | | |
| DC connection type | MC4 (Max. 6 mm ²) | | |
| AC connection type | OT or DT terminal (Max.70 mm ²) | | |
| Compliance | IEC 62109, IEC 61727, IEC 62116, IEC 60068, IEC 61683, VDE-AR-N 4105:2018, VDE-AR-N 4110:2018, IEC 61000-6-3, EN 50438 | | |
| Grid Support | Q at night function (optional), LVRT, HVRT, active & reactive power control and power ramp rate control | | |

10.2 Quality Assurance

When product faults occur during the warranty period, SUNGROW will provide free service or replace the product with a new one.

Evidence

During the warranty period, the customer shall provide the product purchase invoice and date. In addition, the trademark on the product shall be undamaged and legible. Otherwise, SUNGROW has the right to refuse to honor the quality guarantee.

Conditions

- After replacement, unqualified products shall be processed by SUNGROW.
- The customer shall give SUNGROW a reasonable period to repair the faulty device.

Exclusion of Liability

In the following circumstances, SUNGROW has the right to refuse to honor the quality guarantee:

- The free warranty period for the whole machine/components has expired.
- The device is damaged during transport.
- The device is incorrectly installed, refitted, or used.
- The device operates in harsh environment, as described in this manual.
- The fault or damage is caused by installation, repairs, modification, or disassembly performed by a service provider or personnel not from SUNGROW.
- The fault or damage is caused by the use of non-standard or non-SUNGROW components or software.
- The installation and use range are beyond stipulations of relevant international standards.
- The damage is caused by unexpected natural factors.

For faulty products in any of above cases, if the customer requests maintenance, paid maintenance service may be provided based on the judgment of SUNGROW.

10.3 Contact Information

Should you have any question about this product, please contact us.

We need the following information to provide you the best assistance:

- Type of the inverter
- Serial number of the inverter
- Fault code/name
- Brief description of the problem

China (HQ)

SUNGROW POWER SUPPLY Co., Ltd
Hefei
+86 551 65327834
service@sungrowpower.com

Australia

SUNGROW Australia Group Pty. Ltd.
NSW
+61 2 9922 1522
service@sungrowpower.com.au

Brazil

SUNGROW Power do Brasil
Sao Paulo
+55 015 9 98197824
latam.service@sa.sungrowpower.com

France

SUNGROW France – Siege Social
Paris
+33 762899888
service.france@sungrow.co

Germany

SUNGROW Deutschland GmbH
München
+49(0)89 324914761
service.germany@sungrow.co

Greece

Service Partner – Survey Digital
+30 2106044212
service.greece@sungrow.co

Italy

SUNGROW Italy
Milano
+39 3391096413
service.italy@sungrow.co

Japan

SUNGROW Japan K.K.
Tokyo
+81362629918
japanservice@jp.sungrowpower.com

Korea

SUNROW POWER KOREA LIMITED
Seoul
+827077191889
service@kr.sungrowpower.com

Malaysia

SUNGROW SEA
Selangor Darul Ehsan
+6019897 3360
service@my.sungrowpower.com

Philippines

SUNGROW POWER SUPPLY Co., Ltd
Mandaluyong City
+639173022769
service@ph.sungrowpower.com

Thailand

SUNGROW Power (Hong Kong) Co., Ltd.
Bangkok
+66891246053
service@th.sungrowpower.com

Spain

SUNGROW Ibérica S.L.U.
Navarra
service.spain@sungrow.co

Romania

Service Partner - Elerex
+40 241762250
service.romania@sungrow.co

Turkey

SUNGROW Deutschland GmbH Turkey
Istanbul Representative Bureau
Istanbul
+90 2127318883
service.turkey@sungrow.co

UK

SUNGROW Power UK Ltd.
Milton Keynes
+44 (0) 0908 414127
service.uk@sungrow.co

U.S.A, Mexico

SUNGROW USA
Phoenix
+1833 7476937
techsupport@sungrow-na.com

SUNGROW

Sungrow Power Supply Co., Ltd.

Add: No.1699 Xiyou Rd.,New & High Technology Industrial Development Zone, 230088,Hefei, P. R. China.

Post Zip: 230088

Web: www.sungrowpower.com

E-mail: info@sungrow.cn

Tel: +86 551 6532 7834/6532 7845

Fax: +86 551 6532 7856

Specifications are subject to changes without advance notice.