

Operating Manual  
**SUNNY BOY 3.0 / 3.6 / 4.0 / 5.0**

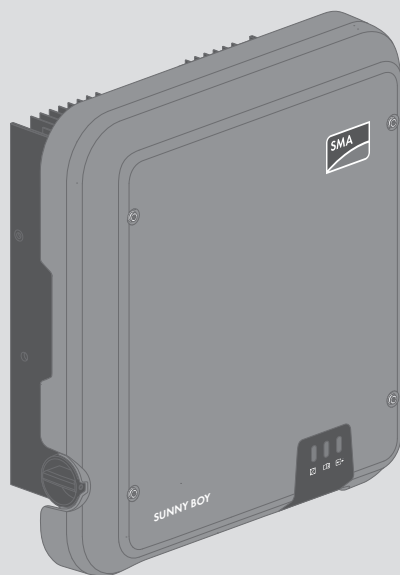

## Legal Provisions

The information contained in these documents is property of SMA Solar Technology AG. Any publication, whether in whole or in part, requires prior written approval by SMA Solar Technology AG. Internal reproduction used solely for the purpose of product evaluation or other proper use is allowed and does not require prior approval.

### SMA Warranty

You can download the current warranty conditions from the Internet at [www.SMA-Solar.com](http://www.SMA-Solar.com).

### Software licenses

The licenses for the used software modules can be called up on the user interface of the product.

### Trademarks

All trademarks are recognized, even if not explicitly identified as such. Missing designations do not mean that a product or brand is not a registered trademark.

Modbus<sup>®</sup> is a registered trademark of Schneider Electric and is licensed by the Modbus Organization, Inc.

QR Code is a registered trademark of DENSO WAVE INCORPORATED.

Phillips<sup>®</sup> and Pozidriv<sup>®</sup> are registered trademarks of Phillips Screw Company.

Torx<sup>®</sup> is a registered trademark of Acument Global Technologies, Inc.

### SMA Solar Technology AG

Sonnenallee 1

34266 Niestetal

Germany

Tel. +49 561 9522-0

Fax +49 561 9522-100

[www.SMA.de](http://www.SMA.de)

Email: [info@SMA.de](mailto:info@SMA.de)

Status: 3/1/2017

Copyright © 2017 SMA Solar Technology AG. All rights reserved.

# Table of Contents

<b>1</b>	<b>Information on this Document .....</b>	<b>6</b>
1.1	Validity .....	6
1.2	Target Group .....	6
1.3	Symbols.....	6
1.4	Additional Information.....	7
1.5	Nomenclature .....	8
1.6	Typographies .....	8
<b>2</b>	<b>Safety .....</b>	<b>9</b>
2.1	Intended Use.....	9
2.2	Safety Information .....	9
<b>3</b>	<b>Scope of Delivery .....</b>	<b>11</b>
<b>4</b>	<b>Product Description .....</b>	<b>12</b>
4.1	Sunny Boy .....	12
4.2	Interfaces and Functions.....	14
4.3	LED Signals .....	16
<b>5</b>	<b>Mounting.....</b>	<b>18</b>
5.1	Requirements for Mounting.....	18
5.2	Mounting the Inverter .....	20
<b>6</b>	<b>Electrical Connection .....</b>	<b>22</b>
6.1	Safety during Electrical Connection .....	22
6.2	Overview of the Connection Area.....	22
6.3	AC Connection .....	23
6.3.1	Requirements for the AC Connection .....	23
6.3.2	Connecting the Inverter to the Utility Grid .....	24
6.3.3	Connecting Additional Grounding.....	27
6.4	Connecting the Network Cables .....	28
6.5	Mounting the WLAN Antenna.....	30
6.6	DC Connection .....	31
6.6.1	Requirements for the DC Connection .....	31
6.6.2	Assembling the DC Connectors .....	31

6.6.3	Connecting the PV Array.....	33
6.6.4	Disassembling the DC Connectors .....	36
<b>7</b>	<b>Commissioning .....</b>	<b>38</b>
7.1	Commissioning Procedure.....	38
7.2	Commissioning the Inverter .....	38
7.3	Configuring the Inverter.....	40
7.4	Starting the Self-Test (For Italy Only) .....	43
<b>8</b>	<b>Using the Inverter User Interface .....</b>	<b>44</b>
8.1	Establishing a connection to the user interface.....	44
8.1.1	Establishing a direct connection via WLAN.....	44
8.1.2	Establishing a Direct Connection via Ethernet .....	45
8.1.3	Establishing a Connection via Ethernet in the local network .....	46
8.2	Logging In and Out of the User Interface .....	47
8.3	Start Page Design of the User Interface .....	49
8.4	Changing the Password .....	52
<b>9</b>	<b>Configuration of the Inverter.....</b>	<b>53</b>
9.1	Changing Operating Parameters .....	53
9.2	Starting the Installation Assistant .....	54
9.3	Configuring the Country Data Set .....	55
9.4	Configuring the Modbus Function .....	55
9.5	Saving the Configuration in a File .....	56
9.6	Adopting a Configuration from a File .....	56
9.7	Activate WPS Function .....	57
9.8	Switching WLAN On and Off .....	57
9.9	Switching the Dynamic Power Display Off .....	58
9.10	Activating the Receipt of Control Signals (Only for Italy) .....	58
9.11	Deactivating Grounding Conductor Monitoring .....	59
9.12	Configuring Feed-In Management .....	59
<b>10</b>	<b>Disconnecting the Inverter from Voltage Sources .....</b>	<b>60</b>
<b>11</b>	<b>Cleaning the Inverter .....</b>	<b>62</b>
<b>12</b>	<b>Troubleshooting.....</b>	<b>63</b>

12.1	Forgotten Password .....	63
12.2	Event Messages .....	64
12.3	Checking the PV System for Ground Faults .....	80
12.4	Updating the Firmware .....	84
<b>13</b>	<b>Decommissioning the Inverter .....</b>	<b>85</b>
<b>14</b>	<b>Technical Data .....</b>	<b>89</b>
14.1	DC/AC .....	89
14.1.1	Sunny Boy 3.0 / 3.6 .....	89
14.1.2	Sunny Boy 4.0 / 5.0 .....	91
14.2	General Data .....	93
14.3	Climatic Conditions .....	94
14.4	Protective Devices .....	94
14.5	Equipment .....	94
14.6	Torques .....	95
14.7	Data Storage Capacity .....	95
<b>15</b>	<b>Contact .....</b>	<b>96</b>
<b>16</b>	<b>EU Declaration of Conformity .....</b>	<b>98</b>

# 1 Information on this Document

## 1.1 Validity

This document is valid for the following device types:







- SB3.0-1AV-40 (Sunny Boy 3.0)
- SB3.6-1AV-40 (Sunny Boy 3.6)
- SB4.0-1AV-40 (Sunny Boy 4.0)
- SB5.0-1AV-40 (Sunny Boy 5.0)

## 1.2 Target Group

This document is intended for qualified persons and end users. Only qualified persons are allowed to perform the activities marked in this document with a warning symbol and the caption "Qualified person". Tasks that do not require any particular qualification are not marked and can also be performed by end users. Qualified persons must have the following skills:

- Knowledge of how an inverter works and is operated
- Training in how to deal with the dangers and risks associated with installing and using electrical devices and installations
- Training in the installation and commissioning of electrical devices and installations
- Knowledge of the applicable standards and directives
- Knowledge of and compliance with this document and all safety information

## 1.3 Symbols

Symbol	Explanation
 <b>DANGER</b>	Indicates a hazardous situation which, if not avoided, will result in death or serious injury
 <b>WARNING</b>	Indicates a hazardous situation which, if not avoided, can result in death or serious injury
 <b>CAUTION</b>	Indicates a hazardous situation which, if not avoided, can result in minor or moderate injury
<b>NOTICE</b>	Indicates a situation which, if not avoided, can result in property damage
 <b>QUALIFIED PERSON</b>	Sections describing activities to be performed by qualified persons only
	Information that is important for a specific topic or goal, but is not safety-relevant
	Indicates a requirement for meeting a specific goal

Symbol	Explanation
☑	Desired result
✘	A problem that might occur

## 1.4 Additional Information

Links to additional information can be found at [www.SMA-Solar.com](http://www.SMA-Solar.com):

Document title	Document type
"Efficiency and Derating" Efficiency and Derating Behavior of the Sunny Boy, Sunny Tripower and Sunny Mini Central Inverters	Technical Information
"Insulation Resistance (Riso) of Non-Galvanically Isolated PV Systems" Information on Insulation Resistance of Non-Galvanically Isolated PV Systems	Technical Information
"Criteria for Selecting a Residual-Current Device" Criteria for Selecting a Residual-Current Device	Technical Information
"Circuit Breaker" Dimensioning and Selection of a Suitable AC Circuit Breaker for Inverters under PV-Specific Influences	Technical Information
"Application for SMA Grid Guard Code"	Form
"Webconnect Systems in Sunny Portal" Registration in Sunny Portal	User Manual
"SMA Modbus® Interface" Information on the commissioning and configuration of the SMA Modbus interface	Technical Information
"SunSpec® Modbus® Interface" Information on the commissioning and configuration of the SunSpec Modbus interface	Technical Information
"SMA Modbus® Interface" List with the product specific SMA Modbus registers	Technical Information
"SunSpec® Modbus® Interface" List with the product specific SunSpec Modbus registers	Technical Information
"Parameters and Measured Values" Overview of All Inverter Operating Parameters and Their Configuration Options	Technical Information

## 1.5 Nomenclature

Complete designation	Designation in this document
Sunny Boy	Inverter, product

## 1.6 Typographies

Typography	Use	Example
<b>bold</b>	<ul style="list-style-type: none"> <li>• Terminals</li> <li>• Slots</li> <li>• Parameters</li> <li>• Elements on the user interface</li> <li>• Elements to be selected</li> <li>• Elements to be entered</li> </ul>	<ul style="list-style-type: none"> <li>• The value can be found in the field <b>Energy</b>.</li> <li>• Select <b>Settings</b>.</li> <li>• Enter <b>10</b> in the field <b>Minutes</b>.</li> </ul>
>	<ul style="list-style-type: none"> <li>• Connects several elements to be selected</li> </ul>	<ul style="list-style-type: none"> <li>• Select <b>Settings &gt; Date</b>.</li> </ul>
[Button]	<ul style="list-style-type: none"> <li>• Button to be selected or pressed</li> </ul>	<ul style="list-style-type: none"> <li>• Select [<b>Next</b>].</li> </ul>



## 2 Safety

### 2.1 Intended Use

The Sunny Boy is a transformerless PV inverter with two MPP trackers which converts the direct current of the PV array to grid-compliant alternating current and feeds it into the utility grid.

The product is suitable for indoor and outdoor use.

The product must only be operated with PV arrays of protection class II in accordance with IEC 61730, application class A. The PV modules must be compatible with this product.

PV modules with a high capacity to ground must only be used if their coupling capacity does not exceed 1.4  $\mu\text{F}$  (for information on how to calculate the coupling capacity, see the Technical Information "Leading Leakage Currents" at [www.SMA-Solar.com](http://www.SMA-Solar.com)).

All components must remain within their permitted operating ranges at all times.

The product must only be used in countries for which it is approved or released by SMA Solar Technology AG and the grid operator.

The product is also approved for the Australian market and may be used in Australia. If DRM support is specified, the inverter may only be used in conjunction with a Demand Response Enabling Device (DRED). This ensures that the inverter implements the commands from the grid operator for active power limitation at all times. The inverter and the Demand Response Enabling Device (DRED) must be connected in the same network and the inverter Modbus interface must be activated and the TCP server set.

Use this product only in accordance with the information provided in the enclosed documentation and with the locally applicable standards and directives. Any other application may cause personal injury or property damage.

Alterations to the product, e.g. changes or modifications, are only permitted with the express written permission of SMA Solar Technology AG. Unauthorized alterations will void guarantee and warranty claims and in most cases terminate the operating license. SMA Solar Technology AG shall not be held liable for any damage caused by such changes.

Any use of the product other than that described in the Intended Use section does not qualify as the intended use.

The enclosed documentation is an integral part of this product. Keep the documentation in a convenient place for future reference and observe all instructions contained therein.

The type label must remain permanently attached to the product.

### 2.2 Safety Information

This section contains safety information that must be observed at all times when working on or with the product.

To prevent personal injury and property damage and to ensure long-term operation of the product, read this section carefully and observe all safety information at all times.

**⚠ DANGER****Danger to life due to high voltages of the PV array**

When exposed to sunlight, the PV array generates dangerous DC voltage, which is present in the DC conductors and the live components of the inverter. Touching the DC conductors or the live components can lead to lethal electric shocks. If you disconnect the DC connectors from the inverter under load, an electric arc may occur leading to electric shock and burns.

- Do not touch non-insulated cable ends.
- Do not touch the DC conductors.
- Do not touch any live components of the inverter.
- Have the inverter mounted, installed and commissioned only by qualified persons with the appropriate skills.
- If an error occurs, have it rectified by qualified persons only.
- Prior to performing any work on the inverter, disconnect it from all voltage sources as described in this document.

**⚠ DANGER****Danger to life due to high voltages in the inverter**

Touching live components within the inverter can lead to lethal electric shocks. Some components also require at least five minutes to discharge after the inverter has been disconnected from voltage sources.

- Do not open the inverter.

**⚠ DANGER****Danger to life due to electric shock**

Touching an ungrounded PV module or array frame can cause a lethal electric shock.

- Connect and ground the PV modules, array frame and electrically conductive surfaces so that there is continuous conduction. Observe the applicable local regulations.

**NOTICE****Damage to the inverter due to the use of cleaning agents**

- If the inverter is dirty, clean the enclosure, the enclosure lid, the type label and the LEDs using only clean water and a cloth.

### 3 Scope of Delivery

Check the scope of delivery for completeness and any externally visible damage. Contact your distributor if the scope of delivery is incomplete or damaged.

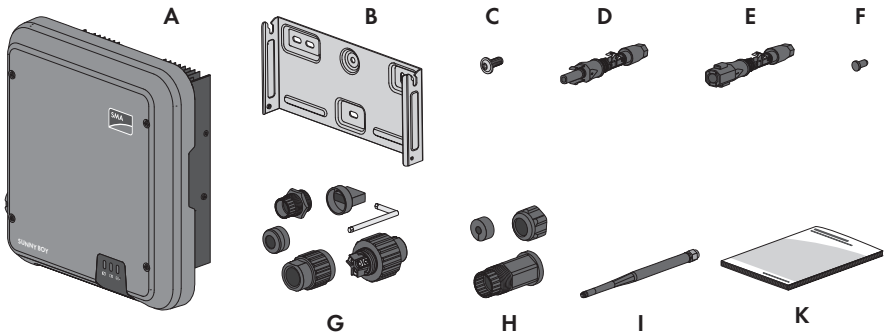

Figure 1: Components included in the scope of delivery

Position	Quantity	Designation
A	1	Inverter
B	1	Wall mounting bracket
C	3	Pan head screw M5x12
D	4	Positive DC connector
E	4	Negative DC connector
F	8	Sealing plug
G	1	AC connector: swivel nut, threaded sleeve with sealing ring, bush insert, locking cap and Torx L key wrench (TX 8)
H	1	RJ45 protective sleeve: threaded sleeve, seal insert, swivel nut
I	1	WLAN antenna
K	1	Quick reference guide with password label on the rear side The label contains the following information: <ul style="list-style-type: none"> <li>• PIC (Product Identification Code) identification key for registering the system in Sunny Portal</li> <li>• RID (Registration Identifier) registration ID for registering the system in Sunny Portal</li> <li>• WLAN password WPA2-PSK (WiFi Protected Access 2 - Preshared Key) for direct connection to the inverter via WLAN</li> </ul>

## 4 Product Description

### 4.1 Sunny Boy

The Sunny Boy is a transformerless PV inverter with two MPP trackers which converts the direct current of the PV array to grid-compliant alternating current and feeds it into the utility grid.

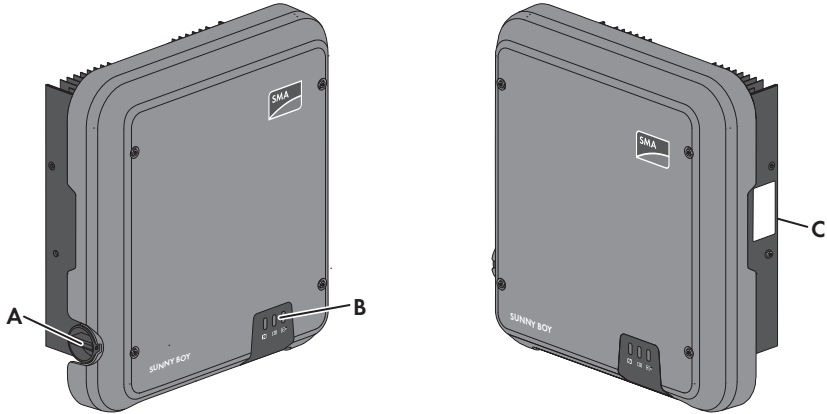















Figure 2: Design of the Sunny Boy

Position	Designation
A	<p>DC load-break switch</p> <p>The inverter is equipped with a DC load-break switch. If the DC load-break switch is set to the position <b>I</b>, it establishes a conductive connection between the PV array and the inverter. Setting the DC load-break switch to the <b>O</b> position interrupts the DC electric circuit and completely disconnects the PV array from the inverter. Disconnection takes place at all poles.</p>

Position	Designation
B	<p>LEDs</p> <p>The LEDs indicate the operating state of the inverter.</p>
C	<p>Type label</p> <p>The type label uniquely identifies the inverter. The type label must remain permanently attached to the product. You will find the following information on the type label:</p> <ul style="list-style-type: none"> <li>• Device type (Model)</li> <li>• Serial number (Serial No.)</li> <li>• Date of manufacture</li> <li>• Identification key (PIC) for registration in Sunny Portal</li> <li>• Registration ID (RID) for registration in Sunny Portal</li> <li>• WLAN password (WPA2-PSK) for the direct connection to the user interface of the inverter via WLAN</li> <li>• Device-specific characteristics</li> </ul>

Symbol	Explanation
	<p>Inverter</p> <p>Together with the green LED, this symbol indicates the operating state of the inverter.</p>
	<p>Observe the documentation</p> <p>Together with the red LED, this symbol indicates an error.</p>
	<p>Data transmission</p> <p>Together with the blue LED, this symbol indicates the status of the network connection.</p>
	<p>Risk of burns due to hot surfaces</p> <p>The product can get hot during operation. Avoid contact during operation. Prior to performing any work on the product, allow the product to cool down sufficiently.</p>
	<p>Danger to life due to electric shock</p> <p>The product operates at high voltages. Prior to performing any work on the product, disconnect the product from voltage sources. All work on the product must be carried out by qualified persons only.</p>
	<p>Observe the documentation</p> <p>Observe all documentation supplied with the product.</p>

Symbol	Explanation
	Danger This symbol indicates that the inverter must be additionally grounded if additional grounding or equipotential bonding is required at the installation site.
	Direct current
	The product is has no galvanic isolation.
	Alternating current
	WEEE designation Do not dispose of the product together with the household waste but in accordance with the disposal regulations for electronic waste applicable at the installation site.
	CE marking The product complies with the requirements of the applicable EU directives.
<b>IP65</b>	Degree of protection IP65 The product is protected against dust intrusion and water jets from any angle.
	The product is suitable for outdoor installation.
	RCM (Regulatory Compliance Mark) The product complies with the requirements of the applicable Australian standards.

## 4.2 Interfaces and Functions

The inverter is equipped with the following interfaces and functions:

### User interface for the monitoring and configuration of the inverter

The inverter is standard-equipped with an integrated web server, which provides a user interface for configuring and monitoring the inverter. The inverter user interface can be called up via the web browser if there is an existing WLAN or Ethernet connection to a computer, tablet PC or smartphone.

## SMA Speedwire

The inverter is equipped with SMA Speedwire as standard. SMA Speedwire is a type of communication based on the Ethernet standard. This enables inverter-optimized 10 or 100 Mbit data transmission between Speedwire devices in PV systems and the user interface of the inverter.

## SMA Webconnect

The inverter is equipped with a Webconnect function as standard. The Webconnect function enables direct data transmission between the inverters of a small-scale system and the Internet portal Sunny Portal without any additional communication device and for a maximum of 4 inverters per Sunny Portal system. If there is an existing WLAN or Ethernet connection, you can directly access your Sunny Portal system via the web browser on the computer, tablet PC or smartphone. Webconnect enables - for PV systems operated in Italy - the connection or disconnection of the inverter to or from the utility grid and the specifying of the frequency limits to be used via IEC61850-GOOSE messages.

## WLAN

The inverter is equipped with a WLAN interface as standard. The inverter is delivered with the WLAN interface activated as standard. If you do not want to use WLAN, you can deactivate the WLAN interface.

In addition, the inverter has a WPS (WiFi Protected Setup) function. The WPS function is for automatically connecting the inverter to a device in the same network as the inverter (e.g. router, computer, tablet PC or smartphone).

## Modbus

The inverter is equipped with a Modbus interface. The Modbus interface is deactivated by default and must be configured as needed.

The Modbus interface of the supported SMA devices is designed for industrial use and has the following tasks:

- Remote query of measured values
- Remote setting of operating parameters
- Setpoint specifications for system control

## Grid Management Services

The inverter is equipped with service functions for grid management.

Depending on the requirements of the grid operator, you can activate and configure the functions (e.g. active power limitation) via operating parameters.

## SMA OptiTrac Global Peak

SMA OptiTrac Global Peak is an advancement of SMA OptiTrac and allows the operating point of the inverter to follow the optimal operating point of the PV array (MPP) precisely at all times. In addition, with the aid of SMA OptiTrac Global Peak, the inverter detects several maximum power points in the available operating range, such as may occur particularly with partially shaded strings. SMA OptiTrac Global Peak is enabled by default.

## All-pole sensitive residual-current monitoring unit

The all-pole sensitive residual-current monitoring unit detects alternating and direct differential currents. In single-phase and three-phase inverters, the integrated differential current sensor detects the current difference between the neutral conductor and the line conductor(s). If the current difference increases suddenly, the inverter disconnects from the utility grid.

## SMA Smart Connected

SMA Smart Connected is the free monitoring of the inverter via the SMA Sunny Portal. Thanks to SMA Smart Connected, the PV system operator and qualified person will be informed automatically and proactively about inverter events that occur.

SMA Smart Connected is activated during registration in Sunny Portal. In order to use SMA Smart Connected, it is necessary that the inverter is permanently connected to Sunny Portal and the data of the PV system operator and qualified person is stored in Sunny Portal and up-to-date.

## 4.3 LED Signals

The LEDs indicate the operating state of the inverter.

LED	Status	Explanation
Green LED	flashing: 2 s on 2 s off	Waiting for connection conditions The conditions for feed-in operation are not yet met. As soon as the conditions are met, the inverter will start feed-in operation.
	flashing quickly	Update of central processing unit The central processing unit of the inverter is being updated.
	glowing	Feed-in operation The inverter feeds in with a power of at least 90%.
	pulsing	Feed-in operation The inverter is equipped with a dynamic power display via the green LED. Depending on the power, the green LED pulses fast or slow. If necessary, you can switch off the dynamic power display via the green LED.
	Off	The inverter is not feeding into the utility grid.
Red LED	glowing	Event occurred If an event occurs, a distinct event message and the corresponding event number will be displayed in addition on the inverter user interface or in the communication product.



LED	Status	Explanation
Blue LED	flashes slowly for approx. one minute	Communication connection is being established The inverter is establishing a connection to a local network or is establishing a direct connection to an end device via Ethernet (e.g. computer, tablet PC or smartphone).
	flashes quickly for approx. two minutes	WPS active The WPS function is active.
	glowing	Communication active There is an active connection with a local network or there is a direct connection with an end device via Ethernet (e.g. computer, tablet PC or smartphone).

## 5 Mounting

### 5.1 Requirements for Mounting

#### Requirements for the mounting location:

#### **⚠ WARNING**

#### **Danger to life due to fire or explosion**

Despite careful construction, electrical devices can cause fires.

- Do not mount the product in areas containing highly flammable materials or gases.
- Do not mount the product in potentially explosive atmospheres.

- The mounting location must be inaccessible to children.
- A solid support surface must be available for mounting, e.g. concrete or masonry. When mounted on drywall or similar materials, the inverter emits audible vibrations during operation which could be perceived as annoying.
- The mounting location must be suitable for the weight and dimensions of the inverter (see Section 14 "Technical Data", page 89).
- The mounting location must not be exposed to direct solar irradiation. Direct solar irradiation can result in the premature aging of the exterior plastic parts of the inverter and direct solar irradiation can cause the inverter to overheat. When becoming too hot, the inverter reduces its power output to avoid overheating.
- The mounting location should be freely and safely accessible at all times without the need for any auxiliary equipment (such as scaffolding or lifting platforms). Non-fulfillment of these criteria may restrict servicing.
- To ensure optimum operation, the ambient temperature should be between  $-25^{\circ}\text{C}$  and  $+40^{\circ}\text{C}$ .
- Climatic conditions must be met (see Section 14 "Technical Data", page 89).

#### Permitted and prohibited mounting positions:

- The inverter must only be mounted in one of the permitted positions. This will ensure that no moisture can penetrate the inverter.
- The inverter should be mounted in such a way that LED signals can be read without difficulty.

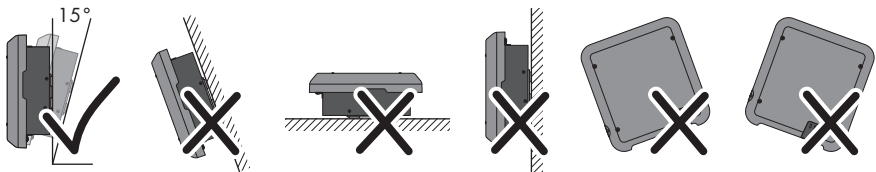

Figure 3: Permitted and prohibited mounting positions:

**Dimensions for mounting:**

Figure 4: Position of the anchoring points (dimensions in mm (in))

**Recommended clearances:**

If you maintain the recommended clearances, adequate heat dissipation will be ensured. Thus, you will prevent power reduction due to excessive temperature.

- Maintain the recommended clearances to walls as well as to other inverters or objects.
- If multiple inverters are mounted in areas with high ambient temperatures, increase the clearances between the inverters and ensure sufficient fresh-air supply.

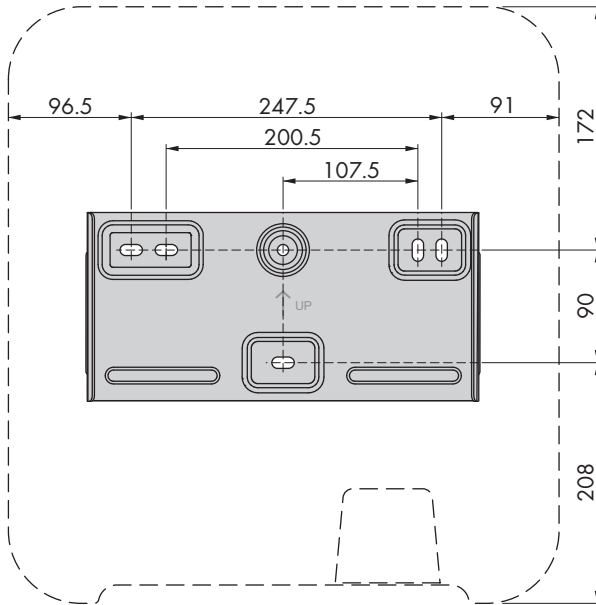
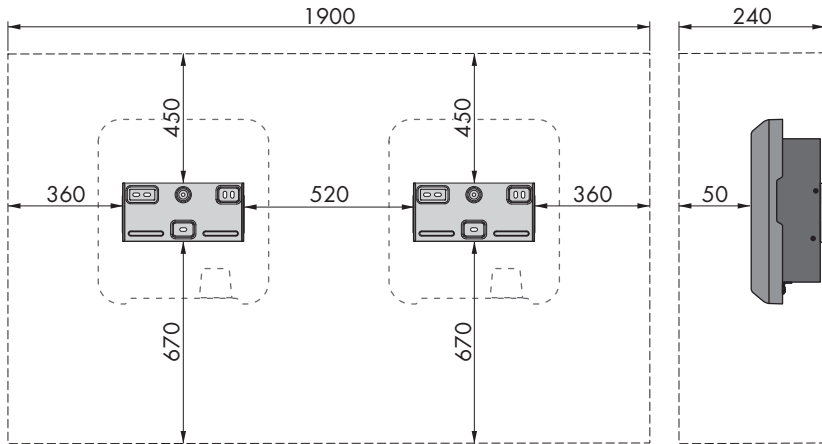

Figure 5: Recommended clearances (dimensions in mm (in))

## 5.2 Mounting the Inverter

### ⚠ QUALIFIED PERSON

**Additionally required mounting material (not included in the scope of delivery):**

- 3 screws, suitable for the support surface and the weight of the inverter (diameter: minimum 6 mm)
- 3 washers, suitable for the screws (outer diameter: minimum 18 mm)
- Where necessary, 3 screw anchors suitable for the support surface and the screws

### ⚠ CAUTION

#### Risk of injury when lifting the inverter, or if it is dropped

The inverter weighs 16 kg. There is risk of injury if the inverter is lifted incorrectly or dropped while being transported or when attaching it to or removing it from the wall mounting bracket.

- Transport and lift the inverter carefully.

#### Procedure:

##### 1. ⚠ CAUTION

#### Risk of injury due to damaged cables

There may be power cables or other supply lines (e.g. gas or water) routed in the wall.

- Ensure that no lines are laid in the wall which could be damaged when drilling holes.

- Align the wall mounting bracket horizontally on the wall and mark the position of the drill holes. Use at least one hole on the right- and left-hand side and the lower hole in the middle of the wall mounting bracket.

Useful hint: When mounting on a post, use the upper and lower central holes of the wall mounting bracket.

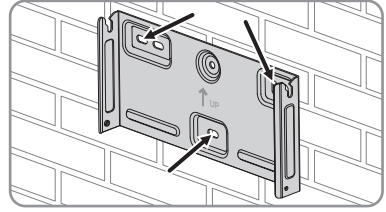

- Set the wall mounting bracket aside and drill the marked holes.
- Insert screw anchors into the drill holes if the support surface requires them.
- Secure the wall mounting bracket horizontally using screws and washers.

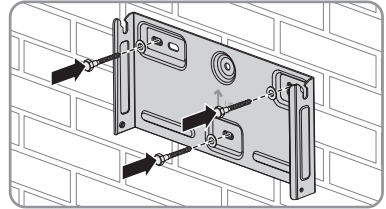

- Hook the inverter into the wall mounting bracket. When doing so, the two right- and left-hand keys on the outer ribs on the rear side of the inverter must be hooked into the respective right-hand and left-hand keyways in the wall mounting bracket.

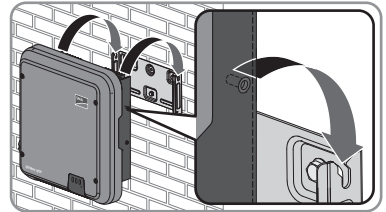

- Ensure that the inverter is securely in place.
- Secure the inverter to the wall mounting bracket. To do so, insert one pan head screw M5x12 each into the lower screw hole on both sides of the inverter anchorage bracket respectively and tighten them using a Torx screwdriver (TX 25, torque: 2.5 Nm).

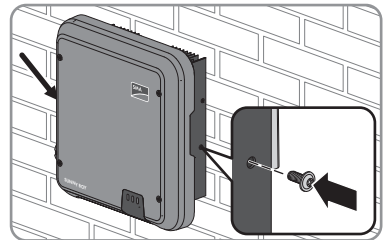

## 6 Electrical Connection

### 6.1 Safety during Electrical Connection

#### **⚠ DANGER**

##### **Danger to life due to high voltages of the PV array**

When exposed to sunlight, the PV array generates dangerous DC voltage, which is present in the DC conductors and the live components of the inverter. Touching the DC conductors or the live components can lead to lethal electric shocks. If you disconnect the DC connectors from the inverter under load, an electric arc may occur leading to electric shock and burns.

- Do not touch non-insulated cable ends.
- Do not touch the DC conductors.
- Do not touch any live components of the inverter.
- Have the inverter mounted, installed and commissioned only by qualified persons with the appropriate skills.
- If an error occurs, have it rectified by qualified persons only.
- Prior to performing any work on the inverter, disconnect it from all voltage sources as described in this document.

### 6.2 Overview of the Connection Area

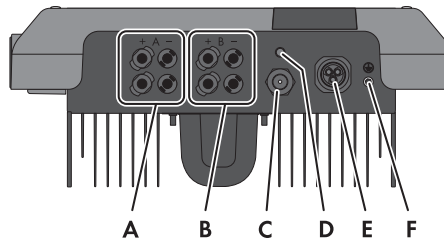

Figure 6: Connection areas at the bottom of the inverter

Position	Designation
A	2 positive and 2 negative DC connectors, input A
B	2 positive and 2 negative DC connectors, input B
C	Network port with protective cap
D	Jack with protective cap for the WLAN antenna
E	Jack for the AC connection
F	Connection point for an additional grounding

## 6.3 AC Connection

### 6.3.1 Requirements for the AC Connection

#### Cable requirements:

- External diameter: 10 mm to 14 mm
- Conductor cross-section: 2.5 to 6 mm<sup>2</sup>
- Insulation stripping length: 12 mm
- Sheath stripping length: 50 mm
- The cable must be dimensioned in accordance with the local and national directives for the dimensioning of cables. The requirements for the minimum wire size derive from these directives. Examples of factors influencing cable dimensioning are: nominal AC current, type of cable, routing method, cable bundling, ambient temperature and maximum desired line losses (for calculation of line losses, see the design software "Sunny Design" from software version 2.0 at [www.SMA-Solar.com](http://www.SMA-Solar.com)).

#### Load-break switch and cable protection:

#### **NOTICE**

#### **Damage to the inverter due to the use of screw-type fuses as load-break switches**

Screw-type fuses (e.g. DIAZED fuse or NEOZED fuse) are not load-break switches.

- Do not use screw-type fuses as load-break switches.
- Use a load-break switch or circuit breaker as a load disconnection unit (for information and design examples, see the Technical Information "Circuit Breaker" at [www.SMA-Solar.com](http://www.SMA-Solar.com)).

- In PV systems with multiple inverters, protect each inverter with a separate circuit breaker. Make sure to observe the maximum permissible fuse protection (see Section 14 "Technical Data", page 89). This will prevent residual voltage being present at the corresponding cable after disconnection.
- Loads installed between the inverter and the circuit breaker must be fused separately.

#### Residual-current monitoring unit:

- If an external residual-current device is required, install a residual-current device which trips at a residual current of 100 mA or higher (for details on selecting a residual-current device, see the Technical Information "Criteria for Selecting a Residual-Current Device" at [www.SMA-Solar.com](http://www.SMA-Solar.com)).

#### Overvoltage category:

The inverter can be used in grids of overvoltage category III or lower in accordance with IEC 60664-1. That means that the inverter can be permanently connected to the grid-connection point of a building. In case of installations with long outdoor cabling routes, additional measures to reduce overvoltage category IV to overvoltage category III are required (see the Technical Information "Overvoltage Protection" at [www.SMA-Solar.com](http://www.SMA-Solar.com)).

**Grounding conductor monitoring:**

The inverter is equipped with a grounding conductor monitoring device. This grounding conductor monitoring device detects when there is no grounding conductor connected and disconnects the inverter from the utility grid if this is the case. Depending on the installation site and grid configuration, it may be advisable to deactivate the grounding conductor monitoring. This is necessary, for example, in an IT system if there is no neutral conductor present and you intend to install the inverter between two line conductors. If you are uncertain about this, contact your grid operator or SMA Solar Technology AG.

- Grounding conductor monitoring must be deactivated after initial start-up depending on the grid configuration (see Section 9.1.1, page 59).

**i** **Safety in accordance with IEC 62109 when the grounding conductor monitoring is deactivated**

In order to guarantee safety in accordance with IEC 62109 when the grounding conductor monitoring is deactivated, carry out one of the following measures:

- Connect a copper-wire grounding conductor with a cross-section of at least 10 mm<sup>2</sup> to the AC connector bush insert.
- Connect an additional grounding that has at least the same cross-section as the connected grounding conductor to the AC connector bush insert (see Section 6.3.3, page 27). This prevents touch current in the event of the grounding conductor on the AC connector bush insert failing.

**i** **Connection of additional grounding**

In some countries, additional grounding is generally required. In each case, observe the locally applicable regulations.

- If additional grounding is required, connect an additional grounding that has at least the same cross-section as the connected grounding conductor to the AC connector bush insert (see Section 6.3.3, page 27). This prevents touch current in the event of the grounding conductor on the AC connector bush insert failing.

## 6.3.2 Connecting the Inverter to the Utility Grid

### **⚠ QUALIFIED PERSON**

**Requirements:**

- The connection requirements of the grid operator must be met.
- The grid voltage must be in the permissible range. The exact operating range of the inverter is specified in the operating parameters.

**Procedure:**

1. Disconnect the circuit breaker and secure it against reconnection.
2. Dismantle the AC cable by 50 mm.



3. Shorten L and N by 8 mm each, so that the grounding conductor is 8 mm longer. This ensures that the grounding conductor is the last to be pulled from the screw terminal in the event of tensile strain.
4. Strip the insulation of L, N and the grounding conductor by 12 mm.
5. In the case of fine stranded wire, the conductors L, N and the grounding conductor are to be fitted with bootlace ferrules.
6. Unscrew the swivel nut from the threaded sleeve and thread the swivel nut and threaded sleeve over the AC cable.

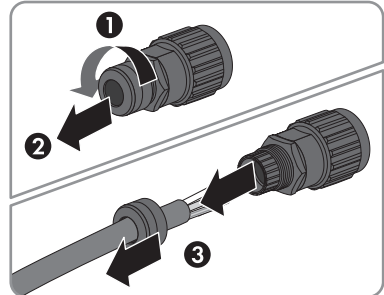

- Insert the grounding conductor into the screw terminal **PE** /  $\oplus$  on the bush insert and tighten the screw using a Torx screwdriver (TX 8, torque: 1.4 Nm).

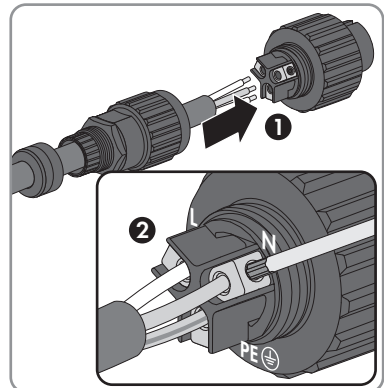

- Insert N - or in the case of installation of the inverter between two line conductors L2 - into the screw terminal **N** on the bush insert and tighten the screw using a Torx screwdriver (TX 8, torque: 1.4 Nm).
  - Insert L - or in the case of installation of the inverter between two line conductors L1 - into the screw terminal **L** on the bush insert and tighten the screw using a Torx screwdriver (TX 8, torque: 1.4 Nm).
7. Ensure that all conductors are securely in place in the screw terminals on the bush insert.

8. Fit the locking cap onto the bush insert. When doing so, position the locking cap so that the key on the locking cap is inserted into the keyway on the bush insert.

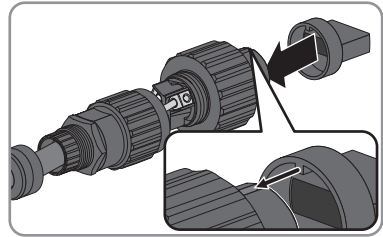

9. Lead the threaded sleeve to the bush insert and screw onto the bush insert. When doing so, hold the bush insert firmly by the locking cap. This ensures that the threaded sleeve can be screwed firmly onto the bush insert.

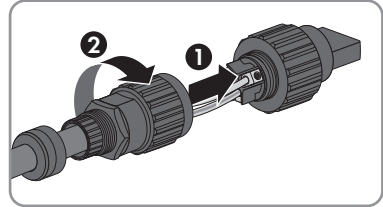

10. Screw the swivel nut onto the threaded sleeve. This seals the AC connector and provides strain relief for the AC cable. When doing so, hold the bush insert firmly by the locking cap. This ensures that the swivel nut can be screwed firmly onto the threaded sleeve.

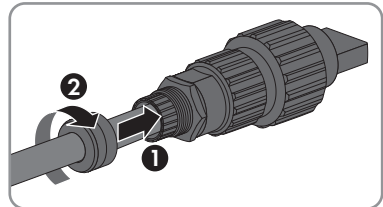

11. Remove the locking cap from the bush insert.

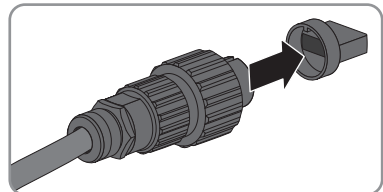

The AC connector is assembled.

12. Plug the AC connector into the jack for the AC connection and screw tight. When doing so, align the AC connector so that the key on the inverter AC jack is inserted into the keyway on the AC connector bush insert.

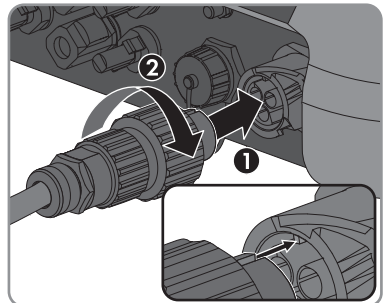

### 6.3.3 Connecting Additional Grounding

#### **⚠ QUALIFIED PERSON**

If additional grounding or equipotential bonding is required locally, you can connect additional grounding to the inverter. This prevents touch current if the grounding conductor on the AC connector fails. The necessary ring terminal lug and the screw are included in the scope of delivery of the inverter.

#### **Additionally required material (not included in the scope of delivery):**

- 1 grounding cable

#### **Cable requirement:**

#### **i Use of fine-stranded conductors**

You can use an inflexible or a flexible, fine-stranded conductor.

- When using a fine-stranded conductor, it has to be double crimped by a ring terminal lug. Make sure that no insulated conductor is visible when pulling or bending. This will ensure sufficient strain relief by means of the ring terminal lug.

- Grounding cable cross-section: max. 10 mm<sup>2</sup>

#### **Procedure:**

1. Strip the grounding cable insulation.
2. Insert the stripped part of the grounding cable into the ring terminal lug and crimp using a crimping tool.

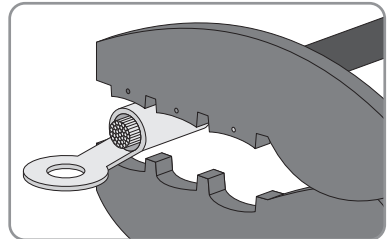

3. Insert the pan head screw M5x12 into the screw hole in the ring terminal lug and screw the ring terminal lug with screw firmly onto the connection point for additional grounding using a Torx screwdriver (TX 25, torque: 2.5 Nm).

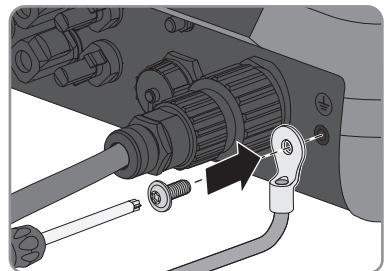

## 6.4 Connecting the Network Cables

### QUALIFIED PERSON

#### DANGER

##### **Danger to life due to electric shock**

Overvoltages (e. g. in the case of a flash of lightning) can be further conducted into the building and to other connected devices in the same network via the network cable if there is no overvoltage protection.

- Ensure that all devices in the same network are integrated in the existing overvoltage protection.
- When laying the network cable outdoors, attention must be given to suitable overvoltage protection at the network cable transition from the inverter outdoors to the network inside the building.
- The Ethernet interface of the inverter is classified as "TNV-1" and offers protection against overvoltages up to 1.5 kV.

##### **Additionally required material (not included in the scope of delivery):**

- One network cable
- Where required: Field-assembly RJ45 connector. SMA Solar Technology AG recommends the connector "MFP8 T568 A Cat.6A" from "Telegärtner".

##### **Cable requirements:**

The cable length and quality affect the quality of the signal. Observe the following cable requirements.

- Cable type: 100BaseTx
- Cable category: Cat5, Cat5e, Cat6, Cat6a or Cat7
- Plug type: RJ45 of Cat5, Cat5e, Cat6 or Cat6a
- Shielding: SF/UTP, S/UTP, SF/FTP or S/FTP
- Number of insulated conductor pairs and insulated conductor cross-section: at least  $2 \times 2 \times 0.22 \text{ mm}^2$
- Maximum cable length between two nodes when using patch cables: 50 m
- Maximum cable length between two nodes with installation cable: 100 m
- UV-resistant for outdoor use

#### **NOTICE**

##### **Damage to the inverter due to moisture ingress**

Moisture penetration can damage the inverter and impair its functionality.

- Connect the network cable with the supplied RJ45 protective sleeve to the inverter.

**Procedure:**1. **⚠ DANGER****Danger to life due to electric shock**

- Disconnect the inverter from all voltage sources (see Section 10, page 60).

2. When using a self-assembly network cable, assemble the RJ45 connector and connect to the network cable (see connector documentation).
3. Unscrew the protective cap from the network port.

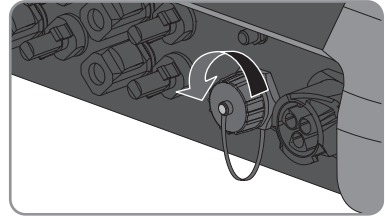

4. Press the cable support sleeve out of the threaded sleeve.
5. Thread the swivel nut and threaded sleeve over the network cable. At the same time, thread the network cable through the opening in the cable support sleeve.

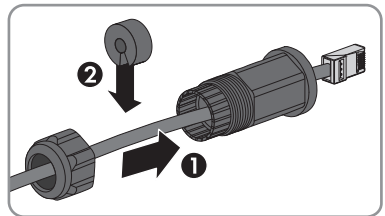

6. Press the cable support sleeve into the threaded sleeve.

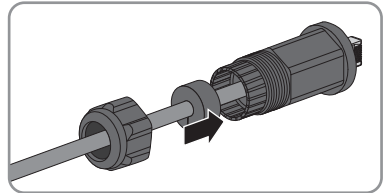

7. Plug the network cable connector into the network port on the inverter and screw the threaded sleeve onto the network port thread on the inverter.

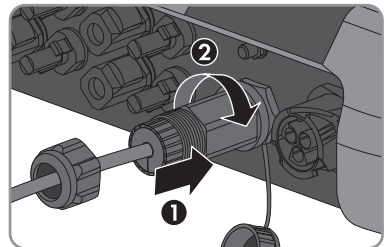

8. Screw the swivel nut onto the threaded sleeve.

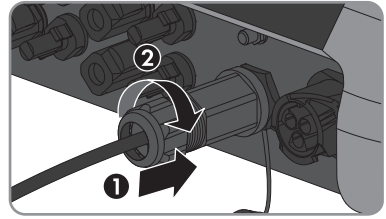

9. If you would like to establish a direct connection, connect the other end of the network cable directly to the computer.
10. If you would like to connect the inverter in a local network, connect the other end of the network cable to the local network (e. g. via a router).

## 6.5 Mounting the WLAN Antenna

### **⚠ QUALIFIED PERSON**

- i** The WLAN antenna can also be used with an extension cord.

If the inverter is mounted in areas without WLAN coverage, the WLAN antenna can be mounted with an extension cord in a location with WLAN coverage.

#### Requirement:

- The WLAN antenna supplied must be used.

#### Procedure:

1. **⚠ DANGER**  
**Danger to life due to electric shock**

- Disconnect the inverter from all voltage sources (see Section 10, page 60).

2. Remove the protective cap from the jack on the inverter.
3. Plug the WLAN antenna into the jack and screw tight (torque: 1 Nm).

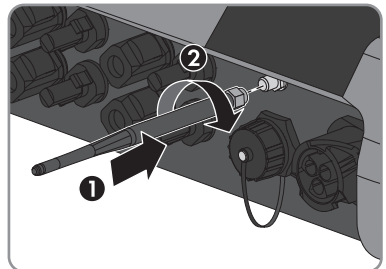

4. Pull on the WLAN antenna to ensure that the WLAN antenna is securely in place.

## 6.6 DC Connection

### 6.6.1 Requirements for the DC Connection

#### Requirements for the PV modules per input:

- All PV modules must be of the same type.
- All PV modules must be aligned and tilted identically.
- On the coldest day based on statistical records, the open-circuit voltage of the PV array must never exceed the maximum input voltage of the inverter.
- The same number of series-connected PV modules must be connected to each string.
- The maximum input current per string must be maintained and must not exceed the through-fault current of the DC connectors (see Section 14 "Technical Data", page 89).
- The thresholds for the input voltage and the input current of the inverter must be adhered to (see Section 14 "Technical Data", page 89).
- The positive connection cables of the PV modules must be fitted with the positive DC connectors (for information on assembling DC connectors, see the DC connector installation manual).
- The negative connection cables of the PV modules must be fitted with the negative DC connector (for information on assembling DC connectors, see the DC connector installation manual).

#### **i** Use of Y adapters for parallel connection of strings

The Y adapters must not be used to interrupt the DC circuit.

- Do not use the Y adapters in the immediate vicinity of the inverter. The adapters must not be visible or freely accessible.
- In order to interrupt the DC circuit, always disconnect the inverter as described in this document (see Section 10, page 60).

### 6.6.2 Assembling the DC Connectors

#### **⚠** QUALIFIED PERSON

For connection to the inverter, all PV module connection cables must be fitted with the DC connectors provided. Assemble the DC connectors as described in the following. Be sure to observe the correct polarity. The DC connectors are marked with the symbols "+" and "-".

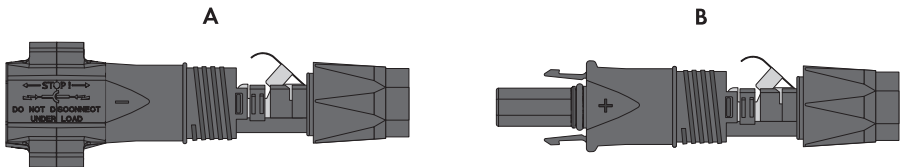

Figure 7: Negative (A) and positive (B) DC connectors

**Cable requirements:**

- Cable type: PV1-F, UL-ZKLA, USE2
- External diameter: 5 mm to 8 mm
- Conductor cross-section: 2.5 mm<sup>2</sup> to 6 mm<sup>2</sup>
- Qty single wires: minimum 7
- Nominal voltage: minimum 1000 V
- Using bootlace ferrules is not allowed.

**⚠ DANGER****Danger to life due to high voltages on the DC conductors**

When exposed to sunlight, the PV array generates dangerous DC voltage which is present in the DC conductors. Touching the DC conductors can lead to lethal electric shocks.

- Ensure that the inverter is disconnected from all voltage sources.
- Do not touch non-insulated cable ends.
- Do not touch the DC conductors.

**NOTICE****Destruction of the inverter due to overvoltage**

If the open-circuit voltage of the PV modules exceeds the maximum input voltage of the inverter, the inverter can be destroyed due to overvoltage.

- If the open-circuit voltage of the PV modules exceeds the maximum input voltage of the inverter, do not connect any strings to the inverter and check the design of the PV system.

**Procedure:**

1. Strip 12 mm of the cable insulation.
2. Insert the stripped cable into the DC connector up to the stop. When doing so, ensure that the stripped cable and the DC connector are of the same polarity.
3. Press the clamping bracket down until it audibly snaps into place.

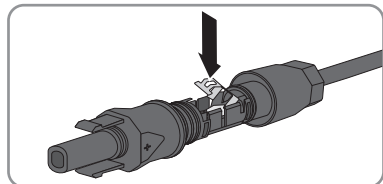
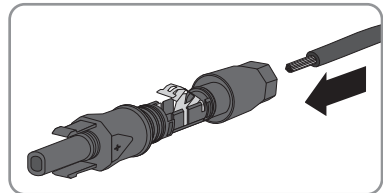



- ☑ The stranded wire can be seen inside the clamping bracket chamber.

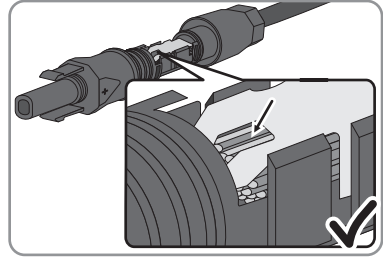

- ✘ The stranded wire cannot be seen in the chamber?

The cable is not correctly in place.

- Release the clamping bracket. To do so, insert a screwdriver (blade width: 3.5 mm) into the clamping bracket and pry the clamping bracket open.

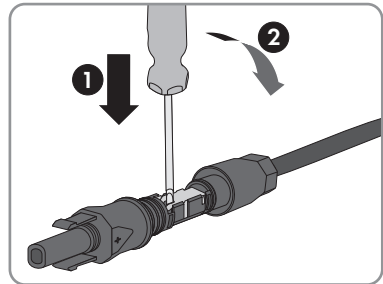

- Remove the cable and go back to step 2.

4. Push the swivel nut up to the thread and tighten (torque: 2 Nm).

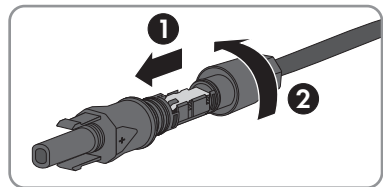

### 6.6.3 Connecting the PV Array

#### ⚠ QUALIFIED PERSON

#### NOTICE

#### Destruction of the inverter due to overvoltage

If the open-circuit voltage of the PV modules exceeds the maximum input voltage of the inverter, the inverter can be destroyed due to overvoltage.

- If the open-circuit voltage of the PV modules exceeds the maximum input voltage of the inverter, do not connect any strings to the inverter and check the design of the PV system.

**NOTICE****Destruction of the measuring device due to overvoltage**

- Only use measuring devices with a DC input voltage range of 1000 V or higher.

**NOTICE****Damage to the DC connectors due the use of contact cleaner of other cleaning agents**

Some contact cleaners or other cleaning agents may contain substances that decompose the plastic of the DC connectors.

- Do not use contact cleaners or other cleaning agents for cleaning the DC connectors.

**Procedure:**

1. Ensure that the circuit breaker is switched off and that it cannot be reconnected.
2. If an external DC load-break switch is installed, disconnect the external DC load-break switch from all voltage sources.
3. Set the DC load-break switch of the inverter to position **0**.

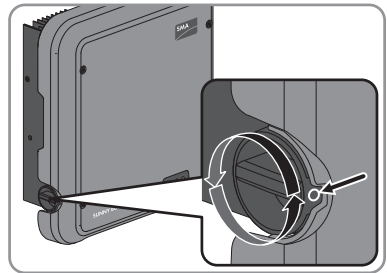

4. Measure the PV array voltage. Ensure that the maximum input voltage of the inverter is adhered to and that there is no ground fault in the PV array.
5. Check whether the DC connectors have the correct polarity.
 

If the DC connector is equipped with a DC cable of the wrong polarity, the DC connector must be reassembled. The DC cable must always have the same polarity as the DC connector.
6. Ensure that the open-circuit voltage of the PV array does not exceed the maximum input voltage.

7. Connect the assembled DC connectors to the inverter.

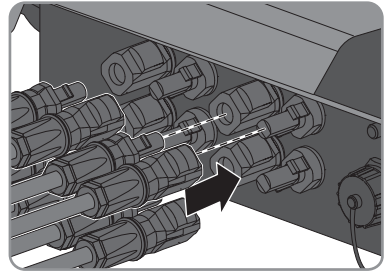

- ☑ The DC connectors snap into place.

8. Ensure that all DC connectors are securely in place.

9. **NOTICE**

**Damage to the inverter due to moisture ingress**

If the electrical connection is not made immediately after the installation, the inverter is not sealed and moisture can penetrate the inverter. The inverter is only sealed if the DC connectors are connected to the inverter with the DC conductors or with sealing plugs.

If the electrical connection is to be carried out at a later time, close the DC inputs on the inverter with DC connectors and sealing plugs as described below.

- Do not insert the sealing plugs directly into the DC inputs on the inverter.
- For unused DC connectors, push down the clamping bracket and push the swivel nut up to the thread.
- Insert the sealing plug into the DC connector.

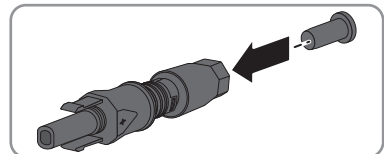

- Insert the DC connectors with sealing plugs into the corresponding DC inputs on the inverter.

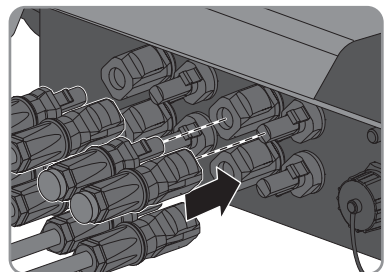

- ☑ The DC connectors snap into place.

- Ensure that the DC connectors with sealing plugs are securely in place.

## 6.6.4 Disassembling the DC Connectors

### ⚠ QUALIFIED PERSON

To disassemble the DC connectors (e.g. due to faulty assembly), proceed as follows.

### ⚠ DANGER

#### Danger to life due to high voltages on the DC conductors

When exposed to sunlight, the PV array generates dangerous DC voltage which is present in the DC conductors. Touching the DC conductors can lead to lethal electric shocks.

- Ensure that the inverter is disconnected from all voltage sources.
- Do not touch non-insulated cable ends.
- Do not touch the DC conductors.

#### Procedure:

1. Release and remove all DC connectors. To do this, insert a flat-blade screwdriver or an angled screwdriver (blade width 3.5 mm) into one of the slide slots and pull the DC connectors out in a downward direction. Do not pull on the cable.

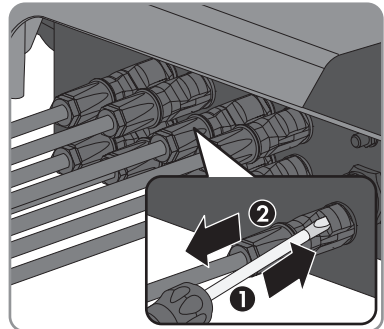

2. Remove the DC connector swivel nut.

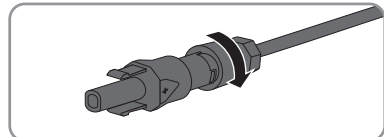

3. Unlock the DC connector. To do this, insert a flat-blade screwdriver (blade width: 3.5 mm) into the side catch mechanism and pry the catch mechanism open.

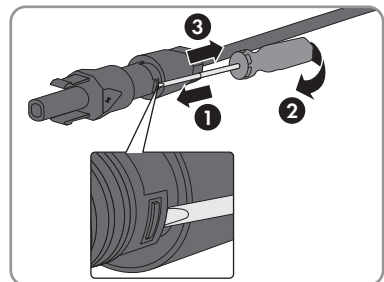

4. Carefully pull the DC connector apart.

5. Release the clamping bracket. To do so, insert a flat-blade screwdriver (blade width: 3.5 mm) into the clamping bracket and pry the clamping bracket open.

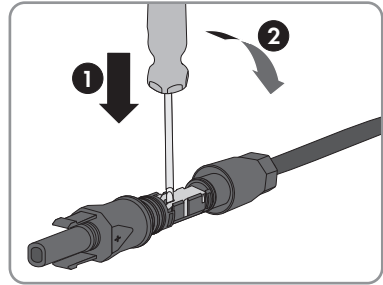

6. Remove the cable.

## 7 Commissioning

### 7.1 Commissioning Procedure

#### QUALIFIED PERSON

This section describes the commissioning procedure and gives an overview of the steps you must perform in the prescribed order.

Procedure	See
1. Commission the inverter.	Section 7.2, page 38
2. Establish a connection to the user interface of the inverter. There are three connection options available to choose from: <ul style="list-style-type: none"> <li>• Direct connection via WLAN</li> <li>• Direct connection via Ethernet</li> <li>• Connection via Ethernet in the local network</li> </ul>	Section 8.1, page 44
3. Log into the user interface.	Section 8.2, page 47
4. Configure the inverter. Please note, that the personal SMA Grid Guard code for changing the grid-relevant parameters must be available after completion of the first ten operating hours (see "Application for the SMA Grid Guard code" available at <a href="http://www.SMA-Solar.com">www.SMA-Solar.com</a> ).	Section 7.3, page 40
5. Ensure that the country data set has been configured correctly.	Section 9.3, page 55
6. For PV systems in Italy: Start the self-test.	Section 7.4, page 43
7. Make further inverter settings as needed.	Section 9, page 53

### 7.2 Commissioning the Inverter

#### QUALIFIED PERSON

#### Requirements:

- The AC circuit breaker must be correctly rated and mounted.
- The inverter must be correctly mounted.
- All cables must be correctly connected.

**Procedure:**

1. Switch on the AC circuit breaker.
2. Turn the DC load-break switch of the inverter to position I.

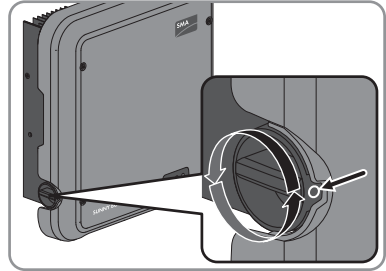

- ☑ All three LEDs light up. The start-up phase begins.
- ☑ All three LEDs go out again after approximately 90 seconds.
- ☑ The green LED starts to flash and, if the inverter is connected via Speedwire, the blue LED also starts to flash.
- ✘ The green LED is still flashing?

The conditions for activating feed-in operation are not yet met.

- As soon as the conditions for feed-in operation are met, the inverter starts with feed-in operation and, depending on the available power, the green LED will light up continuously or it will pulse.

- ✘ The red LED is glowing?

An error has occurred.

- Rectify the error (see Section 12, page 63).

## 7.3 Configuring the Inverter

### **⚠ QUALIFIED PERSON**

After you have logged onto the user interface as **Installer**, the **Configuring the Inverter** page opens.

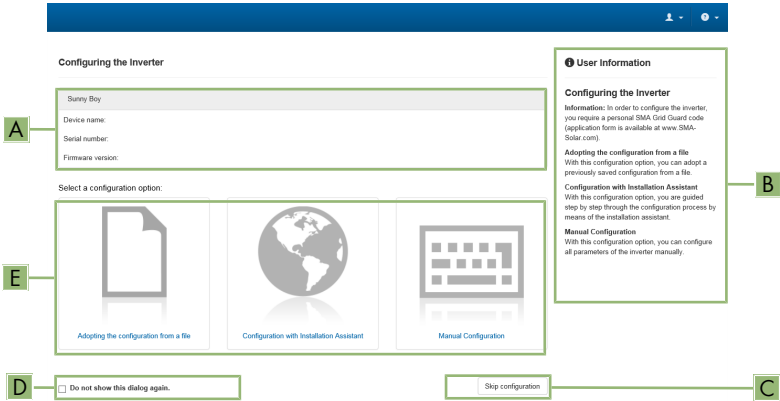

Figure 8: Layout of the **Configuring the Inverter** page

Position	Designation	Description
A	Device information	Provides the following information: <ul style="list-style-type: none"> <li>• Device name</li> <li>• Inverter serial number</li> <li>• Inverter firmware version</li> </ul>
B	User information	Provides brief information on the listed configuration options
C	Skip configuration	Offers the option of skipping the inverter configuration and go directly to the user interface (not recommended)
D	Checkbox	Allows you to choose not to have the displayed page displayed again when the user interface is called up again
E	Configuration options	Provides a selection of the various configuration options



**Procedure:**

On the **Configuring the Inverter** page, three configuration options are available to choose from. Select one of the three options and proceed for the selected option as described below. SMA Solar Technology AG recommends carrying out the configuration with the Installation Assistant. This way, you ensure that all relevant parameters are set for optimal inverter operation.

- Adopt the configuration from a file
- Configuration with the Installation Assistant (recommended)
- Manual configuration

** Accepting the settings**

Saving the made settings is indicated by an hourglass symbol on the user interface. If the DC voltage is sufficient, the data is transferred directly to the inverter and accepted. If the DC voltage is too low (e. g. in the evening), the settings are saved, but they cannot be directly transferred to or accepted by the inverter. As long as the inverter has not yet received and accepted the settings, the hourglass symbol will continue to be displayed on the user interface. The settings will be accepted when there is sufficient DC voltage applied and the inverter restarts. As soon as the hourglass symbol appears on the user interface, the settings have been saved. The settings will not be lost. You can log off of the user interface and leave the system.

**Adopting the Configuration From a File**

You can adopt the inverter configuration from a file. To do this, there must be an inverter configuration saved to a file.

**Procedure:**

1. Select the configuration option **Adopting configuration from a file**.
2. Select [**Browse...**] and select the desired file.
3. Select [**Import file**].

## Configuration with the Installation Assistant (Recommended)

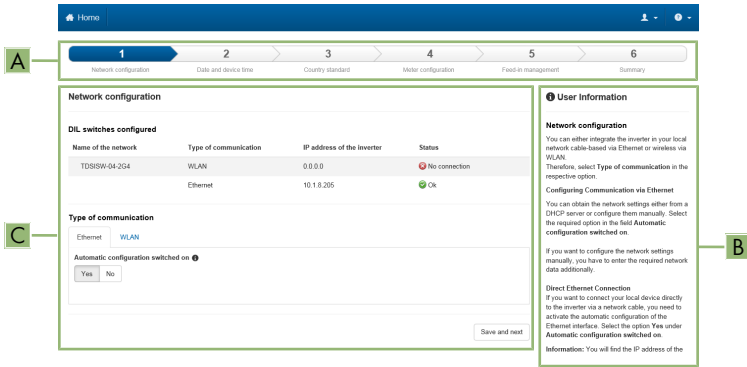

Figure 9: Layout of the installation assistant

Position	Designation	Description
A	Configuration steps	Overview of the installation assistant steps. The number of steps depends on the type of device and the additionally installed modules. The current step is highlighted in blue.
B	User information	Information about the current configuration step and the setting options of the configuration step.
C	Configuration field	You can make settings in this field.

### Procedure:

1. Select the configuration option **Configuration with Installation Assistant**.
  - The Installation Assistant will open.
2. Follow the Installation Assistant steps and make the settings appropriate for your system.
3. For every setting made in a step, select [**Save and next**].
  - In the last step, all made settings are listed in a summary.
4. To save the settings to a file, select [**Export a summary**] and save the file on your computer, tablet PC or smartphone.
5. To correct settings you made, select [**Back**], navigate to the desired step, correct settings and select [**Save and continue**].
6. Once all settings are correct, select [**Next**] in the summary.
  - The start page of the user interface opens.

### Manual Configuration

You can configure the inverter manually by setting the desired parameters.

**Procedure:**

1. Select the configuration option **Manual Configuration**.
  - The **Device Parameters** menu on the user interface will open and all available parameter groups of the inverter will be displayed.
2. Select [**Edit parameters**].
3. Select the desired parameter group.
  - All available parameters of the parameter group will be displayed.
4. Set the desired parameters.
5. Select [**Save all**].
  - The inverter parameters are set.

## 7.4 Starting the Self-Test (For Italy Only)

### QUALIFIED PERSON

The self-test is only required for inverters to be commissioned in Italy. The Italian standard requires that all inverters feeding into the utility grid are equipped with a self-test function in accordance with CEI 0-21. During the self-test, the inverter will consecutively check the reaction times for overvoltage, undervoltage, maximum frequency and minimum frequency.

The self-test changes the upper and lower disconnection values for each protective function on a linear basis for frequency monitoring and voltage monitoring. As soon as the measured value exceeds the permitted disconnection threshold, the inverter disconnects from the utility grid. In this way, the inverter determines the reaction time and checks itself.

After the self-test has been completed, the inverter automatically switches back to feed-in operation, resets the original disconnection conditions and connects to the utility grid. The test takes approximately three minutes.

**Requirements:**

- The country data set of the inverter must be set to **CEI 0-21 internal**.

**Procedure:**

1. Select the menu **Device Configuration**.
2. Select [**Settings**].
3. Select [**Starting the Self-Test**] in the subsequent context menu.
4. Observe the instructions shown in the dialog and save the report of the self-test, if necessary.

## 8 Using the Inverter User Interface

### 8.1 Establishing a connection to the user interface

#### 8.1.1 Establishing a direct connection via WLAN

##### Requirements:

- The inverter must be commissioned.
- A computer, tablet PC or smartphone with WLAN interface must be available.
- In the case of a computer connection, one of the following web browsers must be installed: Firefox (as of version 25), Internet Explorer (as of version 10), Safari (as of version 7), Opera (as of version 17) or Google Chrome (as of version 30).
- In the case of a tablet PC or smartphone connection, one of the following web browsers must be installed: Firefox (as of version 25), Safari (as of version iOS 7) or Google Chrome (as of version 29).
- The personal SMA Grid Guard code of the Installer must be available for the changing of grid-relevant settings after completion of the first ten operating hours (see "Application for SMA Grid Guard Code" at [www.SMA-Solar.com](http://www.SMA-Solar.com)).

##### **i** Inverter SSID and IP address and necessary passwords

- Inverter SSID in WLAN: SMA[serial number] (e.g. SMA2130019815)
- Standard WLAN password (usable for initial configuration to completion of the first ten operating hours): SMA 12345
- Device-specific WLAN password (usable for initial configuration to completion of the first ten operating hours): see WPA2-PSK on the type label of the inverter or on the back of the manual included in the delivery
- Standard IP inverter address for a direct connection via WLAN outside of a local network: 192.168.12.3

##### **i** Importing and exporting files with end devices having an iOS operating system is not possible.

For technical reasons, importing and exporting files (e.g. importing an inverter configuration, saving the current inverter configuration or exporting events) is not possible with mobile end devices having an iOS operating system.

- Use an end device that does not have an iOS operating system for importing and exporting files.

The procedure can be different depending on the terminal devices used (e.g. computer, tablet PC or smartphone). If the procedure described does not apply to your device, establish the direct connection via WLAN as described in the manual of your device.

**Procedure:**

1. If your computer, tablet PC or smartphone has a WPS function:
  - Activate the WPS function on the inverter. To do this, tap on the enclosure lid of the inverter twice.
    - The blue LED flashes quickly for approx. two minutes. The WPS function is active.
  - Activate the WPS on your device.
    - The connection with your device will be established automatically. It can take up to 20 seconds for this connection to be established.
2. If your computer, tablet PC or smartphone does not have a WPS function:
  - Search for WLAN networks with your device.
  - Select the SSID of the inverter **SMA[serial number]** in the list with the found WLAN networks.
  - Enter the inverter WLAN password. Within the first 10 operating hours, you must use the standard WLAN password **SMA12345**. After the first 10 operating hours, you must use the device-specific WLAN password (WPA2-PSK) of the inverter. The WLAN password (WPA2-PSK) is printed on the type label.
3. Enter the IP address **192.168.12.3** or, if your device supports mDNS services, **SMA[serial number].local** in the address line of the web browser and press the enter key.
4.  **Web browser signals a security vulnerability**

After the IP address has been confirmed by pressing the enter key, a message might appear indicating that the connection to the user interface of the inverter is not secure. SMA Solar Technology AG guarantees that calling up the user interface is secure.

  - Continue loading the user interface.
  - The login page of the user interface opens.

## 8.1.2 Establishing a Direct Connection via Ethernet

**Requirements:**

- The inverter must be commissioned.
- A computer with an Ethernet interface must be available.
- The inverter must be connected directly to a computer.
- One of the following web browsers must be installed: Firefox (as of version 25), Internet Explorer (as of version 10), Safari (as of version 7), Opera (as of version 17) or Google Chrome (as of version 30).
- The personal SMA Grid Guard code of the Installer must be available for the changing of grid-relevant settings after completion of the first ten operating hours (see certificate "Application for SMA Grid Guard Code" at [www.SMA-Solar.com](http://www.SMA-Solar.com)).

** IP address of the inverter**

- Standard inverter IP address for direct connection via Ethernet: 169.254.12.3

**Procedure:**

1. Open the web browser of your device, enter the IP address **169.254.12.3** in the address line and press the enter key.
  2.  **Web browser signals a security vulnerability**  
 After the IP address has been confirmed by pressing the enter key, a message might appear indicating that the connection to the user interface of the inverter is not secure. SMA Solar Technology AG guarantees that calling up the user interface is secure.
    - Continue loading the user interface.
- The login page of the user interface opens.

### 8.1.3 Establishing a Connection via Ethernet in the local network

#### New IP address for connecting with a local network

If the inverter is connected to a local network via a network cable (e.g. via a router), the inverter will receive a new IP address. Depending on the type of configuration, the new IP address will be assigned automatically by the DHCP server (router) or manually by you. Upon completion of the configuration, the inverter is only reachable via this new IP address or the alternative addresses.

Access addresses of the inverter:

- Generally applicable access address, e.g. for android products: IP address manually assigned or assigned by the DHCP server (router) (identification via network scanner software or router manual).
- Alternative access address for Apple products: SMA[serial number].local (e.g. SMA2130019815.local)
- Alternative access address for certain Windows products: SMA[serial number] (e.g. SMA2130019815)

**Requirements:**

- The inverter must be connected to the local network via a network cable (e.g. via a router).
- The inverter must be integrated in the local network.
- A computer, tablet PC or smartphone must be available and the computer, tablet PC or smartphone must be connected with the network to which the inverter is also connected.
- In the case of a computer connection, one of the following web browsers must be installed: Firefox (as of version 25), Internet Explorer (as of version 10), Safari (as of version 7), Opera (as of version 17) or Google Chrome (as of version 30).
- In the case of a tablet PC or smartphone connection, one of the following web browsers must be installed: Firefox (as of version 25), Safari (as of version iOS 7) or Google Chrome (as of version 29).

- The personal SMA Grid Guard code of the Installer must be available for the changing of grid-relevant settings after completion of the first ten feed-in hours (see certificate "Application for SMA Grid Guard Code" at [www.SMA-Solar.com](http://www.SMA-Solar.com)).

**Procedure:**

1. Open the web browser of your device, enter the IP address of the inverter in the address line of the web browser and press the enter key.
  2.  **Web browser signals a security vulnerability**  
After the IP address has been confirmed by pressing the enter key, a message might appear indicating that the connection to the user interface of the inverter is not secure. SMA Solar Technology AG guarantees that calling up the user interface is secure.
    - Continue loading the user interface.
- The login page of the user interface opens.

## 8.2 Logging In and Out of the User Interface

After a connection to the user interface of the inverter has been established, the login page opens. Log onto the user interface as described below.

### Usage of cookies

For the correct display of the user interface, cookies are required. The cookies are used for convenience only. By using this user interface you agree to the placement of cookies.

### Log in as installer or user for the first time

**Procedure:**

1. In the drop-down list **Language**, select the desired language.
  2. In the **User group** drop-down list, select the entry **Installer** or **User**.
  3. In the **New password** field, enter a new password for the selected user group.
  4. In the **Repeat password** field, enter the new password again.
  5. Select **Login**.
- The **Configuring the Inverter** page or the user interface start page opens.

### Log in as the User or Installer

1. In the drop-down list **Language**, select the desired language.
  2. In the **User group** drop-down list, select the entry **Installer** or **User**.
  3. Enter the password in the field **Password**.
  4. Select **Login**.
- The start page of the user interface opens.

## Log Out as the User or Installer

1. On the right-hand side of the menu bar, select the menu **User Settings**.
  2. In the subsequent context menu, select [**Logout**].
- The login page of the user interface opens. The logout was successful.



### 8.3 Start Page Design of the User Interface

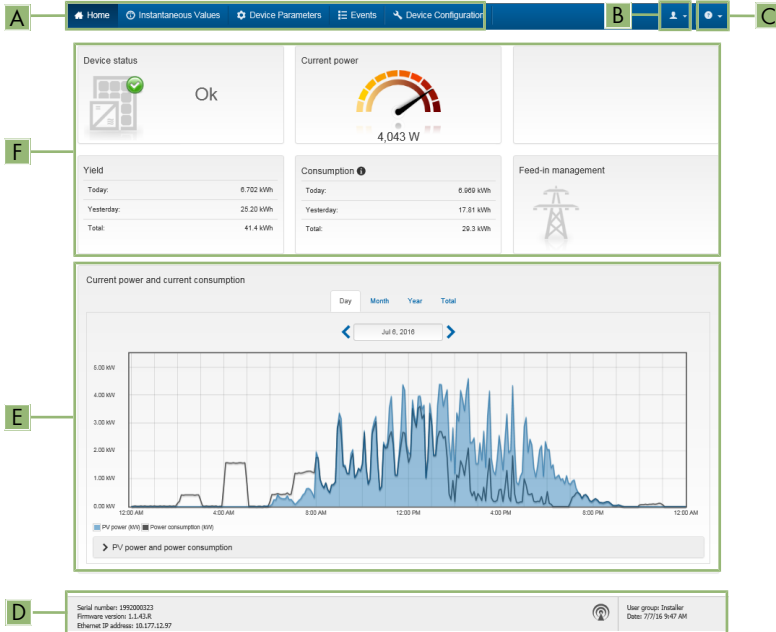

Figure 10: Start page design of the user interface (example)

Position	Designation	Description
A	Menu	<p>Provides the following functions:</p> <ul style="list-style-type: none"> <li>• <b>Home</b> Opens the user interface homepage</li> <li>• <b>Instantaneous values</b> Current measured values of the inverter</li> <li>• <b>Device Parameters</b> The various operating parameters of the inverter can be viewed and configured here depending on the user group.</li> <li>• <b>Events</b> All events that have occurred in the selected time period are displayed here. The event types are <b>Information</b>, <b>Warning</b> and <b>Error</b>. Currently existing events of the types <b>Error</b> and <b>Warning</b> will be additionally displayed in the <b>Device status</b> viewlet. However, only the higher-priority event is displayed. If, for example, there is a Warning and an Error present at the same time, only the Error will be displayed.</li> <li>• <b>Device configuration</b> The following settings for the inverter can be performed here. The selection is, however, dependent on the user group logged in and the set country data set. <ul style="list-style-type: none"> <li>- Changing the device name</li> <li>- Updating firmware (not available with devices having an iOS operating system)</li> <li>- Saving a configuration to file (not available with devices having an iOS operating system)</li> <li>- Loading a configuration from a file (not available with devices having an iOS operating system)</li> <li>- Importing a proxy certificate (not available with devices having an iOS operating system)</li> <li>- Start the self-test</li> </ul> </li> </ul>
B	User settings	<p>Provides the following functions, depending on the user group logged in:</p> <ul style="list-style-type: none"> <li>• Start the installation assistant</li> <li>• SMA Grid Guard login</li> <li>• Logout</li> </ul>

Position	Designation	Description
C	Help	<p>Provides the following functions:</p> <ul style="list-style-type: none"> <li>• Displaying information on Open Source licenses used</li> <li>• Link to the website of SMA Solar Technology AG</li> </ul>
D	Status bar	<p>Displays the following information:</p> <ul style="list-style-type: none"> <li>• Inverter serial number</li> <li>• Inverter firmware version</li> <li>• IP addresses of the inverter within the local network and/or IP address of the inverter during WLAN connection</li> <li>• With WLAN connection: Signal strength of WLAN connection</li> <li>• User group logged in</li> <li>• Date and device time of the inverter</li> </ul>
E	PV power and power consumption progression	<p>Temporal progression of the PV power and the power consumption of the household over the selected time period. Please note, the power consumption will only be displayed if an energy meter is installed in the PV system.</p>
F	Status display	<p>The various areas display information on the current status of the PV system.</p> <ul style="list-style-type: none"> <li>• <b>Device status</b> Displays whether the inverter is currently in a fault-free operating state or whether there is an Error or Warning present.</li> <li>• <b>Current power</b> Displays the power currently being generated by the inverter.</li> <li>• <b>Current consumption</b> Displays the current consumption of the household if an energy meter is installed in the PV system.</li> <li>• <b>Yield</b> Displays the energy yield of the inverter.</li> <li>• <b>Consumption</b> Displays the energy consumption of the household if an energy meter is installed in the PV system.</li> <li>• <b>Feed-in management</b> Displays whether the inverter is currently limiting its active power.</li> </ul>

## 8.4 Changing the Password

The password for the inverter can be changed for both user groups. Furthermore, the user group **Installer** can change the password for the user group **User** as well as its own password.

### Procedure:

1. Activate the user interface (see Section 8.1, page 44).
2. Log into the user interface (see Section 8.2, page 47).
3. Call up the menu **Device Parameters**.
4. Select [**Edit parameters**].
5. In the parameter group **User Rights > Access Control** change the password of the desired user group.
6. Select [**Save all**] to save the changes.

## 9 Configuration of the Inverter

### 9.1 Changing Operating Parameters

The operating parameters of the inverter are set to certain values by default. You can change the operating parameters to optimize the performance of the inverter.

This section describes the basic procedure for changing operating parameters. Always change operating parameters as described in this section. Some function-sensitive parameters can only be viewed by qualified persons and can only be changed by qualified persons by entering the personal SMA Grid Guard code.

#### **No configuration via Sunny Explorer**

Sunny Explorer does not support the configuration of inverters with their own user interface. The inverter can be detected via Sunny Explorer, however it is expressly not recommended to use Sunny Explorer to configure this inverter. SMA Solar Technology AG does not accept liability for missing or incorrect data and possibly resulting yield losses.

- Use the user interface for the configuration of the inverter.

#### **Requirements:**

- The changes to the grid-relevant parameters must be approved by the grid operator.
- When changing grid-relevant parameters, the SMA Grid Guard code must be available (see "Application for SMA Grid Guard Code" at [www.SMA-Solar.com](http://www.SMA-Solar.com)).

#### **Procedure:**

1. Activate the user interface (see Section 8.1, page 44).
  2. Log into the user interface (see Section 8.2, page 47).
  3. Call up the menu **Device Parameters**.
  4. Select [**Edit parameters**].
  5. Log in using the SMA Grid Guard code to change those parameters designated by a lock (only for installers):
    - Select the menu **User Settings** (see Section 8.3, page 49).
    - In the subsequent context menu, select [**SMA Grid Guard login**].
    - Enter the SMA Grid Guard code and select [**Login**].
  6. Expand the parameter group that contains the parameter which is to be configured.
  7. Change the desired parameters.
  8. Select [**Save all**] to save the changes.
- The inverter parameters are set.

**i** **Accepting the settings**

Saving the made settings is indicated by an hourglass symbol on the user interface. If the DC voltage is sufficient, the data is transferred directly to the inverter and accepted. If the DC voltage is too low (e. g. in the evening), the settings are saved, but they cannot be directly transferred to or accepted by the inverter. As long as the inverter has not yet received and accepted the settings, the hourglass symbol will continue to be displayed on the user interface. The settings will be accepted when there is sufficient DC voltage applied and the inverter restarts. As soon as the hourglass symbol appears on the user interface, the settings have been saved. The settings will not be lost. You can log off of the user interface and leave the system.

## 9.2 Starting the Installation Assistant

**▲ QUALIFIED PERSON**

The installation assistant leads you step-by-step through the steps necessary for the initial configuration of the inverter.

**Layout of the installation assistant**

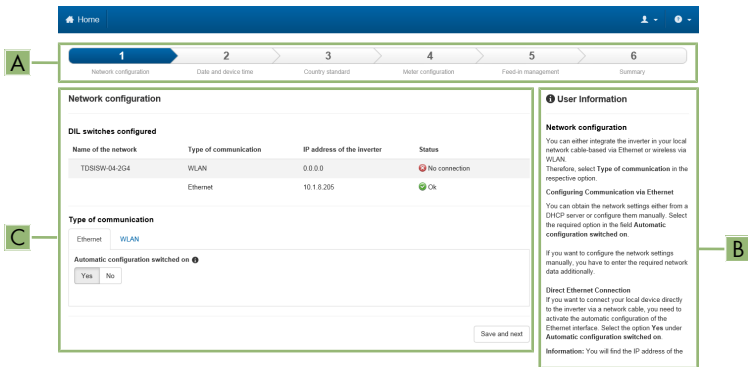

Figure 11: Layout of the installation assistant

Position	Designation	Description
A	Configuration steps	Overview of the installation assistant steps. The number of steps depends on the type of device and the additionally installed modules. The current step is highlighted in blue.
B	User information	Information about the current configuration step and the setting options of the configuration step.
C	Configuration field	You can make settings in this field.

**Requirement:**

- When configuring after completion of the first ten operating hours, the SMA Grid Guard code must be available (see "Application for SMA Grid Guard Code" at [www.SMA-Solar.com](http://www.SMA-Solar.com)).

**Procedure:**

1. Activate the user interface (see Section 8.1, page 44).
  2. Log in as **Installer**.
  3. Select the menu **User Settings** (see Section 8.3, page 49) on the start page of the user interface.
  4. In the context menu, select [**Start the installation assistant**].
- The Installation Assistant will open.

## 9.3 Configuring the Country Data Set

### QUALIFIED PERSON

By default, the inverter is set to a universally valid country data set. You can adjust the country data set for the installation site retroactively.

#### The country data set must be set correctly.

If you select a country data set which is not valid for your country and purpose, it can cause a disturbance in the PV system and lead to problems with the grid operator. When selecting the country data set, you must always observe the locally applicable standards and directives as well as the properties of the PV system (e.g. PV system size, grid-connection point).

- If you are not sure which country data set is valid for your country or purpose, contact your grid operator for information on which country data set is to be configured.

The basic procedure for changing operating parameters is explained in another section (see Section 9.1 "Changing Operating Parameters", page 53).

**Procedure:**

- In the parameter group **Grid monitoring > Grid monitoring** select the parameter **Set country standard** and set the required country data set.

## 9.4 Configuring the Modbus Function

### QUALIFIED PERSON

The Modbus interface is deactivated by default and the communication ports 502 set. In order to access SMA inverters with SMA Modbus® or SunSpec® Modbus®, the Modbus interface must be activated. After activating the interface, the communication ports of both IP protocols can be changed.

For information on commissioning and configuration of the Modbus interface, see the Technical Information "SMA Modbus® Interface" or in the Technical Information "SunSpec® Modbus® Interface" at [www.SMA-Solar.com](http://www.SMA-Solar.com).

For information on which Modbus registers are supported, see the Technical Descriptions "SMA Modbus® Interface" or "SunSpec® Modbus® Interface" at [www.SMA-Solar.com](http://www.SMA-Solar.com).

### **Data security during activated Modbus interface**

If you activate the Modbus interface, there is a risk that unauthorized users may access and manipulate the data or devices in your PV system.

- Take appropriate protective measures such as:
  - Set up a firewall.
  - Close unnecessary network ports.
  - Only enable remote access via VPN tunnel.
  - Do not set up port forwarding at the communication port in use.
  - In order to deactivate the Modbus interface, reset the inverter to default settings or deactivate the activated parameter again.

#### **Procedure:**

- Activate the Modbus interface and adjust the communication ports if necessary (see the Technical Information "SMA Modbus® Interface" or "SunSpec® Modbus® Interface" at [www.SMA-Solar.com](http://www.SMA-Solar.com)).

## 9.5 Saving the Configuration in a File

You can save the current configuration of the inverter in a file. You can use this file as a data backup for this inverter and then import this file into this inverter again or another inverter to configure the inverter. When saving, only the device parameters will be saved, not any passwords.

#### **Procedure:**

1. Activate the user interface (see Section 8.1, page 44).
2. Log into the user interface (see Section 8.2, page 47).
3. Select the menu **Device Configuration**.
4. Select [**Settings**].
5. In the context menu, select [**Saving the configuration in a file**].
6. Follow the instructions in the dialog.

## 9.6 Adopting a Configuration from a File

### **QUALIFIED PERSON**

To configure the inverter, you can adopt the configuration from a file. To be able to do this, you must first save the configuration of another inverter in a file (see Section 9.5 "Saving the Configuration in a File", page 56). When saving, only the device parameters will be adopted, not any passwords.

#### **Requirements:**

- The SMA Grid Guard code must be available (see "Application for SMA Grid Guard Code" at [www.SMA-Solar.com](http://www.SMA-Solar.com)).
- Changes to grid-relevant parameters must be approved by the responsible grid operator.



**Procedure:**

1. Activate the user interface (see Section 8.1, page 44).
2. Log into the user interface as an **Installer**.
3. Select the menu **Device Configuration**.
4. Select [**Settings**].
5. In the context menu, select [**Adopting the configuration from a file**].
6. Follow the instructions in the dialog.

## 9.7 Activate WPS Function

- Activate the WPS function on the inverter. To do this, tap on the enclosure lid of the inverter twice.
  - The blue LED flashes quickly for approx. two minutes. The WPS function is active.

## 9.8 Switching WLAN On and Off

The inverter is equipped with an activated WLAN interface as standard. If you do not want to use WLAN, you can switch the WLAN function off and switch it on again whenever needed. In doing so, you can switch the WLAN direct connection and the WLAN connection in the local network on independently of each other.

### **Switching on the WLAN function only possible via Ethernet connection**

If you switch off both the WLAN function for the direct connection and for the connection in the local network, access to the inverter user interface and therefore reactivation of the WLAN interface is only possible via an Ethernet connection.

The basic procedure for changing operating parameters is explained in another section (see Section 9.1 "Changing Operating Parameters", page 53).

### Switching WLAN Off

If you would like to switch the WLAN function off completely, you must switch off both the direct connection and the connection in the local network.

**Procedure:**

- To switch off the direct connection in the parameter group **PV system communication > WLAN**, select the parameter **Soft-access-point is turned on** and set this to **No**.
- To switch off the connection in the local network in the parameter group **PV system communication > WLAN**, select the parameter **WLAN is turned on** and set this to **No**.

### Switching WLAN On

If you have switched the WLAN function for direct connection or for connection in the local network off, you can switch the WLAN function back on in accordance with the following procedure.

**Requirement:**

- If the WLAN function was previously switched off completely, the inverter must be connected to a computer or router via Ethernet.

**Procedure:**

- To switch on the WLAN direct connection, in the parameter group **PV system communication > WLAN**, select the parameter **Soft-access-point is turned on** and set this to **Yes**.
- To switch on the WLAN connection in the local network, in the parameter group **System communication > WLAN**, select the parameter **WLAN is turned on** and set this to **Yes**.

## 9.9 Switching the Dynamic Power Display Off

As standard, the inverter signals its power dynamically via the pulsing of the green LED. When doing so, the LED flashes on and off uniformly or is permanently lit at full power. The various gradations are related here to the set active power limit of the inverter. If this display is not desired, switch this function off in accordance with the following procedure. Once this has been done, the green LED is lit permanently to signalize feed-in operation.

The basic procedure for changing operating parameters is explained in another section (see Section 9.1 "Changing Operating Parameters", page 53).

**Procedure:**

- In the parameter group **Device > Operation**, select the parameter **Dynamic power display via green LED** and set this to **Off**.

## 9.10 Activating the Receipt of Control Signals (Only for Italy)

### QUALIFIED PERSON

In order for PV systems in Italy to receive control commands from the grid operator, set the following parameters.

The basic procedure for changing operating parameters is explained in another section (see Section 9.1 "Changing Operating Parameters", page 53).

Parameters	Value/range	Resolution	Default
Application ID	0 to 16384	1	16384
GOOSE-Mac address	01:0C:CD:01:00:00 to 01:0C:CD:01:02:00	1	01:0C:CD:01:00:00

**Procedure:**

1. Select the parameter group **External communication > IEC 61850 configuration**.
  2. In the field **Application ID**, enter the application ID of the grid operator gateway. You will receive this value from your grid operator. You can enter a value between 0 and 16384. The value 16384 indicates "deactivated".
  3. In the field **GOOSE-Mac address**, enter the MAC address of the grid operator gateway from which the inverter is to receive the control commands. You will receive this value from your grid operator.
- The receipt of control signals from the grid operator is activated.

## 9.11 Deactivating Grounding Conductor Monitoring

### QUALIFIED PERSON

If the inverter is to be installed in an IT network or another grid configuration in which deactivation of the grounding conductor monitoring is required, deactivate the grounding conductor monitoring as follows.

The basic procedure for changing operating parameters is explained in another section (see Section 9.1 "Changing Operating Parameters", page 53).

#### Procedure:

- In the parameter group **Grid monitoring > Grid monitoring > Country standard** set the parameter **PE connection monitoring** to **Off**.

## 9.12 Configuring Feed-In Management

### QUALIFIED PERSON

If required by the grid operator, the inverter can provide grid management services. You can configure these via the inverter feed-in management. Coordinate the configuration of the feed-in management with your grid operator beforehand.

The basic procedure for changing operating parameters is explained in another section (see Section 9.1 "Changing Operating Parameters", page 53).

#### Procedure:

1. Activate the user interface (see Section 8.1, page 44).
2. Log into the user interface as an **Installer**.
3. On the right-hand side of the menu bar, select the menu **User Settings** (see Section 8.3 "Start Page Design of the User Interface", page 49).
4. In the subsequent context menu, select [**Start the installation assistant**].
5. Select [**Save and next**] until you arrive in the menu **Feed-in management**.
6. Configure the feed-in management as desired.

## 10 Disconnecting the Inverter from Voltage Sources

### ⚠ QUALIFIED PERSON

Prior to performing any work on the inverter, always disconnect it from all voltage sources as described in this section. Always adhere to the prescribed sequence.

#### NOTICE

#### Destruction of the measuring device due to overvoltage

- Only use measuring devices with a DC input voltage range of 1000 V or higher.

#### Procedure:

1. Disconnect the AC circuit breaker and secure it against reconnection.
2. Set the DC load-break switch of the inverter to .

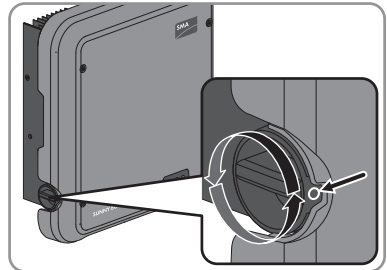

3. Wait until the LEDs have gone out.
4. Use a current clamp to ensure that no current is present in the DC cables.

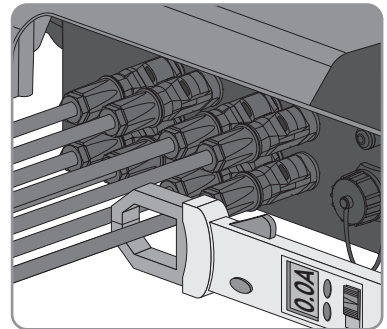

5. Release and remove the DC connectors. To do this, insert a flat-blade screwdriver or an angled screwdriver (blade width: 3.5 mm) into one of the slide slots and pull the DC connectors out in a downward direction. Do not pull on the cable.

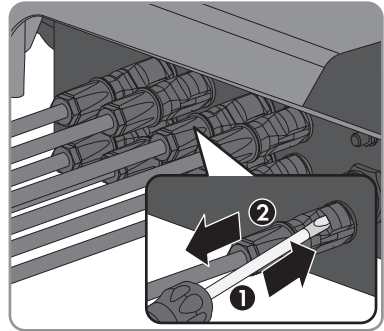

6. Ensure that no voltage is present at the DC inputs on the inverter using a suitable measuring device.

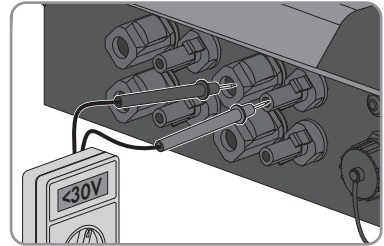

7. Unscrew the AC connector and pull it out of the jack for the AC connection.

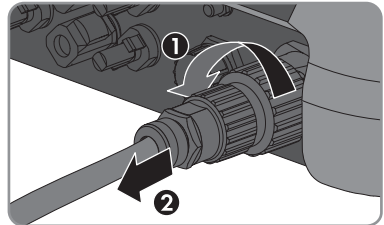

# 11 Cleaning the Inverter

***NOTICE*****Damage to the inverter due to the use of cleaning agents**

- If the inverter is dirty, clean the enclosure, the enclosure lid, the type label and the LEDs using only clean water and a cloth.
- Ensure that the inverter is free of dust, foliage and other dirt.

## 12 Troubleshooting

### 12.1 Forgotten Password

If you have forgotten the password for the inverter, you can unlock the inverter with a Personal Unlocking Key (PUK). For each inverter, there is one PUK for each user group (**User** and **Installer**). Useful hint: With PV systems in Sunny Portal, you can also assign a new password via Sunny Portal for the user group **Installer**. The password for the user group **Installer** is the same as the system password in Sunny Portal.

#### Procedure:

1. Request PUK (application form available at [www.SMA-Solar.com](http://www.SMA-Solar.com)).
2. Activate the user interface (see Section 8.1, page 44).
3. Enter the PUK instead of the password into the field **Password**.
4. Select **Login**.
5. Call up the menu **Device Parameters**.
6. Select [**Edit parameters**].
7. In the parameter group **User Rights > Access Control** change the password of the desired user group.
8. Select [**Save all**] to save the changes.

#### PV Systems in Sunny Portal

The password for the user group **Installer** is also the system password for the PV system in Sunny Portal. Changing the password of the user group **Installer** can lead to the inverter no longer being able to be reached by Sunny Portal.

- Assign the changed password of the user group **Installer** as the new system password in Sunny Portal (see the Sunny Portal user manual at [www.SMA-Solar.com](http://www.SMA-Solar.com)).

## 12.2 Event Messages

Event number	Message, cause and corrective measures
101	<p data-bbox="311 236 591 272"><b>⚠ QUALIFIED PERSON</b></p> <p data-bbox="288 288 393 316"><b>Grid fault</b></p> <p data-bbox="288 323 983 379">The grid voltage or grid impedance at the connection point of the inverter is too high. The inverter has disconnected from the utility grid.</p> <p data-bbox="288 387 508 414"><b>Corrective measures:</b></p> <ul data-bbox="311 422 997 478" style="list-style-type: none"> <li>• Check whether the grid voltage at the connection point of the inverter is permanently in the permissible range.</li> </ul> <p data-bbox="333 491 994 603">If the grid voltage is outside the permissible range due to local grid conditions, contact the grid operator. The grid operator must agree with an adjustment of the voltage at the feed-in point or with a change of the monitored operating limits.</p> <p data-bbox="333 611 1000 699">If the grid voltage is permanently within the permissible range and this message is still displayed, contact the Service (see Section 15 "Contact", page 96).</p>
301	<p data-bbox="311 710 591 746"><b>⚠ QUALIFIED PERSON</b></p> <p data-bbox="288 762 393 790"><b>Grid fault</b></p> <p data-bbox="288 798 997 906">The ten-minute average value of the grid voltage is no longer within the permissible range. The grid voltage or grid impedance at the connection point is too high. The inverter disconnects from the utility grid to maintain power quality.</p> <p data-bbox="288 914 508 941"><b>Corrective measures:</b></p> <ul data-bbox="311 949 997 1005" style="list-style-type: none"> <li>• During the feed-in operation, check whether the grid voltage at the connection point of the inverter is permanently in the permissible range.</li> </ul> <p data-bbox="333 1018 994 1129">If the grid voltage is outside the permissible range due to local grid conditions, contact the grid operator. The grid operator must agree with an adjustment of the voltage at the feed-in point or with a change of the monitored operating limits.</p> <p data-bbox="333 1137 1000 1225">If the grid voltage is permanently within the permissible range and this message is still displayed, contact the Service (see Section 15 "Contact", page 96).</p>



Event number	Message, cause and corrective measures
401	<p data-bbox="311 183 596 220"><b>⚠ QUALIFIED PERSON</b></p> <p data-bbox="288 236 392 260"><b>Grid fault</b></p> <p data-bbox="288 272 1012 327">The inverter has disconnected from the utility grid. A stand-alone grid or a very large change in the power frequency was detected.</p> <p data-bbox="288 336 508 360"><b>Corrective measures:</b></p> <ul data-bbox="311 370 902 424" style="list-style-type: none"> <li data-bbox="311 370 902 424">• Check the grid connection for significant short-term frequency fluctuations.</li> </ul>
501	<p data-bbox="311 438 596 475"><b>⚠ QUALIFIED PERSON</b></p> <p data-bbox="288 491 392 515"><b>Grid fault</b></p> <p data-bbox="288 528 992 582">The power frequency is not within the permissible range. The inverter has disconnected from the utility grid.</p> <p data-bbox="288 592 508 616"><b>Corrective measures:</b></p> <ul data-bbox="311 625 913 679" style="list-style-type: none"> <li data-bbox="311 625 913 679">• If possible, check the power frequency and observe how often fluctuations occur.</li> </ul> <p data-bbox="333 689 996 775">If fluctuations occur frequently and this message is displayed often, contact the grid operator and request approval to change the operating parameters of the inverter.</p> <p data-bbox="333 785 938 871">If the grid operator gives his approval, discuss any changes to the operating parameters with Service (see Section 15 "Contact", page 96).</p>
601	<p data-bbox="311 882 596 919"><b>⚠ QUALIFIED PERSON</b></p> <p data-bbox="288 935 392 959"><b>Grid fault</b></p> <p data-bbox="288 971 978 1026">The inverter has detected an excessively high proportion of direct current in the grid current.</p> <p data-bbox="288 1035 508 1059"><b>Corrective measures:</b></p> <ul data-bbox="311 1069 976 1155" style="list-style-type: none"> <li data-bbox="311 1069 745 1093">• Check the grid connection for direct current.</li> <li data-bbox="311 1102 976 1155">• If this message is displayed frequently, contact the grid operator and check whether the monitoring threshold on the inverter can be raised.</li> </ul>

Event number	Message, cause and corrective measures
801	<p data-bbox="311 185 594 220"><b>⚠ QUALIFIED PERSON</b></p> <p data-bbox="288 236 960 263"><b>Waiting for grid voltage &gt; Grid failure &gt; Check AC circuit breaker</b></p> <p data-bbox="288 272 1012 327">The AC cable is not correctly connected or the country data set is not correctly configured.</p> <p data-bbox="288 336 508 360"><b>Corrective measures:</b></p> <ul data-bbox="311 370 997 571" style="list-style-type: none"> <li>• Make sure that the circuit breaker is switched on.</li> <li>• Ensure that the AC cable is not damaged and that it is connected correctly.</li> <li>• Ensure that the country data set has been configured correctly.</li> <li>• Check whether the grid voltage at the connection point of the inverter is permanently in the permissible range.</li> </ul> <p data-bbox="333 587 994 699">If the grid voltage is outside the permissible range due to local grid conditions, contact the grid operator. The grid operator must agree with an adjustment of the voltage at the feed-in point or with a change of the monitored operating limits.</p> <p data-bbox="333 708 997 794">If the grid voltage is permanently within the permissible range and this message is still displayed, contact the Service (see Section 15 "Contact", page 96).</p>
901	<p data-bbox="311 802 594 837"><b>⚠ QUALIFIED PERSON</b></p> <p data-bbox="288 853 664 880"><b>PE conn. missing &gt; Check connection</b></p> <p data-bbox="288 890 766 917">The grounding conductor is not correctly connected.</p> <p data-bbox="288 927 508 951"><b>Corrective measures:</b></p> <ul data-bbox="311 960 885 987" style="list-style-type: none"> <li>• Ensure that the grounding conductor is correctly connected.</li> </ul>

Event number	Message, cause and corrective measures
3401 to 3407	<p data-bbox="311 185 596 220"><b>⚠ QUALIFIED PERSON</b></p> <p data-bbox="288 236 695 263"><b>DC overvoltage &gt; Disconnect generator</b></p> <p data-bbox="288 272 820 300">Overvoltage at the DC input. This can destroy the inverter.</p> <p data-bbox="288 308 917 335">This message is signaled additionally by rapid flashing of the LEDs.</p> <p data-bbox="288 343 508 370"><b>Corrective measures:</b></p> <ul data-bbox="311 378 1005 691" style="list-style-type: none"> <li data-bbox="311 378 1005 432">• <b>Immediately</b> disconnect the inverter from all voltage sources (see Section 10, page 60).</li> <li data-bbox="311 440 1005 528">• Check whether the DC voltage is below the maximum input voltage of the inverter. If the DC voltage is below the maximum input voltage of the inverter, reconnect the DC connectors to the inverter.</li> <li data-bbox="311 536 1005 624">• If the DC voltage exceeds the maximum input voltage of the inverter, ensure that the PV array has been correctly rated or contact the installer of the PV array.</li> <li data-bbox="311 632 1005 691">• If this message is repeated frequently, contact the Service (see Section 15 "Contact", page 96).</li> </ul>
3501	<p data-bbox="311 707 596 742"><b>⚠ QUALIFIED PERSON</b></p> <p data-bbox="288 758 659 785"><b>Insulation failure &gt; Check generator</b></p> <p data-bbox="288 794 801 821">The inverter has detected a ground fault in the PV array.</p> <p data-bbox="288 829 508 857"><b>Corrective measures:</b></p> <ul data-bbox="311 865 962 892" style="list-style-type: none"> <li data-bbox="311 865 962 892">• Check the PV system for ground faults (see Section 12.3, page 80).</li> </ul>
3701	<p data-bbox="311 903 596 938"><b>⚠ QUALIFIED PERSON</b></p> <p data-bbox="288 954 678 981"><b>Resid.curr.too.high &gt; Check generator</b></p> <p data-bbox="288 991 1009 1045">The inverter has detected a residual current due to temporary grounding of the PV array.</p> <p data-bbox="288 1053 508 1080"><b>Corrective measures:</b></p> <ul data-bbox="311 1088 962 1115" style="list-style-type: none"> <li data-bbox="311 1088 962 1115">• Check the PV system for ground faults (see Section 12.3, page 80).</li> </ul>
3801 to 3805	<p data-bbox="311 1131 596 1166"><b>⚠ QUALIFIED PERSON</b></p> <p data-bbox="288 1182 642 1209"><b>DC overcurrent &gt; Check generator</b></p> <p data-bbox="288 1219 981 1246">Overcurrent at the DC input. The inverter briefly interrupts feed-in operation.</p> <p data-bbox="288 1254 508 1281"><b>Corrective measures:</b></p> <ul data-bbox="311 1289 956 1342" style="list-style-type: none"> <li data-bbox="311 1289 956 1342">• If this message is displayed frequently, ensure that the PV array has been correctly rated and wired.</li> </ul>

Event number	Message, cause and corrective measures
6002 to 6412	<p data-bbox="311 183 599 215"><b>⚠ QUALIFIED PERSON</b></p> <p data-bbox="288 231 655 263"><b>Self diagnosis &gt; Interference device</b></p> <p data-bbox="288 268 711 300">The cause must be determined by the Service.</p> <p data-bbox="288 304 509 336"><b>Corrective measures:</b></p> <ul data-bbox="311 336 868 368" style="list-style-type: none"> <li>• Contact the Service (see Section 15 "Contact", page 96).</li> </ul>
6502	<p data-bbox="311 383 599 414"><b>⚠ QUALIFIED PERSON</b></p> <p data-bbox="288 430 638 462"><b>Self-diagnosis &gt; Overtemperature</b></p> <p data-bbox="288 467 828 499">The inverter has switched off due to excessive temperature.</p> <p data-bbox="288 504 509 536"><b>Corrective measures:</b></p> <ul data-bbox="311 536 991 711" style="list-style-type: none"> <li>• Clean the cooling fins on the rear of the enclosure and the air ducts on the top using a soft brush.</li> <li>• Ensure that the inverter has sufficient ventilation.</li> <li>• Ensure that the ambient temperature +40°C has not been exceeded.</li> <li>• Ensure that the inverter is not exposed to direct solar irradiation.</li> </ul>
6512	<p data-bbox="288 726 756 758"><b>Minimum operating temperature not reached</b></p> <p data-bbox="288 762 952 818">The inverter will only recommence grid feed-in once the temperature has reached at least -25°C.</p>
6603 to 6604	<p data-bbox="311 829 599 861"><b>⚠ QUALIFIED PERSON</b></p> <p data-bbox="288 877 560 909"><b>Self-diagnosis &gt; Overload</b></p> <p data-bbox="288 914 711 946">The cause must be determined by the Service.</p> <p data-bbox="288 951 509 983"><b>Corrective measures:</b></p> <ul data-bbox="311 983 868 1015" style="list-style-type: none"> <li>• Contact the Service (see Section 15 "Contact", page 96).</li> </ul>
6701 to 6702	<p data-bbox="311 1021 599 1053"><b>⚠ QUALIFIED PERSON</b></p> <p data-bbox="288 1069 554 1101"><b>Communication disturbed</b></p> <p data-bbox="288 1106 991 1169">Error in the communication processor, the inverter continues feeding in, however. The cause must be determined by the Service.</p> <p data-bbox="288 1174 509 1206"><b>Corrective measures:</b></p> <ul data-bbox="311 1206 918 1270" style="list-style-type: none"> <li>• If this message is displayed frequently, contact the Service (see Section 15 "Contact", page 96).</li> </ul>

Event number	Message, cause and corrective measures
7102	<p><b>⚠ QUALIFIED PERSON</b></p> <p><b>Parameter file not found or defective</b></p> <p>The parameter file was not found or is defective. The update failed. The inverter continues feeding power into the grid.</p> <p><b>Corrective measures:</b></p> <ul style="list-style-type: none"> <li>• Copy the parameter file to the correct folder again.</li> </ul>
7105	<p><b>⚠ QUALIFIED PERSON</b></p> <p><b>Param. setting failed</b></p> <p>Parameters could not be set using the memory card. The inverter continues feeding power into the grid.</p> <p><b>Corrective measures:</b></p> <ul style="list-style-type: none"> <li>• Ensure that the parameters are set correctly.</li> <li>• Ensure that the SMA Grid Guard code is available.</li> </ul>
7106	<p><b>Update file defect.</b></p> <p>The update file is defective. The update failed. The inverter continues feeding power into the grid.</p>
7110	<p><b>No update file found</b></p> <p>No new update file was found on the SD memory card. The update failed. The inverter continues feeding power into the grid.</p>
7112	<p><b>Update file successfully copied</b></p>
7113	<p><b>The memory card is full or write-protected</b></p>
7201 to 7202	<p><b>Data storage not possible</b></p>
7303	<p><b>⚠ QUALIFIED PERSON</b></p> <p><b>Update main CPU failed</b></p> <p>The cause must be determined by the Service.</p> <p><b>Corrective measures:</b></p> <ul style="list-style-type: none"> <li>• Contact the Service (see Section 15 "Contact", page 96).</li> </ul>
7320	<p><b>The device with serial number [xx] was successfully updated to firmware version [xxx].</b></p> <p>The firmware update was completed successfully.</p>
7330	<p><b>Condition test failed</b></p> <p>The testing of the update conditions was successful. The firmware update package is suitable for this inverter.</p>

Event number	Message, cause and corrective measures
7331	<p><b>Update transport started</b> Update file is being copied.</p>
7332	<p><b>Update transport successful</b> Update file was copied successfully to the inverter's internal memory.</p>
7333	<p><b>⚠ QUALIFIED PERSON</b></p> <p><b>Update transport failed</b> Update file could not be copied to the inverter's internal memory. In the event of connection with the inverter via WLAN, a poor connection quality can be the cause.</p> <p><b>Corrective measures:</b></p> <ul style="list-style-type: none"> <li>• Retry update.</li> <li>• For WLAN connection: Improve the WLAN connection quality (e.g. via WLAN repeater) or establish connection with the inverter via Ethernet.</li> <li>• If this message is displayed again, contact the Service (see Section 15 "Contact", page 96).</li> </ul>
7341	<p><b>Update Bootloader</b> The inverter is performing a bootloader update.</p>
7342	<p><b>⚠ QUALIFIED PERSON</b></p> <p><b>Update Bootloader failed</b> The bootloader update failed.</p> <p><b>Corrective measures:</b></p> <ul style="list-style-type: none"> <li>• Retry update.</li> <li>• If this message is displayed again, contact the Service (see Section 15 "Contact", page 96).</li> </ul>
7347	<p><b>⚠ QUALIFIED PERSON</b></p> <p><b>Incompatible file</b> The configuration file is not suitable for this inverter.</p> <p><b>Corrective measures:</b></p> <ul style="list-style-type: none"> <li>• Ensure that the selected configuration file is suitable for this inverter.</li> <li>• Retry import.</li> </ul>

Event number	Message, cause and corrective measures
7348	<p><b>⚠ QUALIFIED PERSON</b></p> <p><b>Incorrect file format</b> The configuration file is not of the required format or is damaged.</p> <p><b>Corrective measures:</b></p> <ul style="list-style-type: none"> <li>• Ensure that the selected configuration file is of the required format and is not damaged.</li> <li>• Retry import.</li> </ul>
7349	<p><b>Incorrect login rights for configuration file</b> The user group logged in does not have the user rights necessary to be able to import a configuration.</p> <p><b>Corrective measures:</b></p> <ul style="list-style-type: none"> <li>• Log in as <b>Installer</b>.</li> <li>• Import configuration file again.</li> </ul>
7350	<p><b>Transfer of a configuration file has started</b> The configuration file is being transferred.</p>
7351	<p><b>Update WLAN</b> The inverter is updating the WLAN module.</p>
7352	<p><b>Update of WLAN not successful</b> The update of the WLAN module failed.</p> <p><b>Corrective measures:</b></p> <ul style="list-style-type: none"> <li>• Retry update.</li> <li>• If this message is displayed again, contact the Service (see Section 15 "Contact", page 96).</li> </ul>
7353	<p><b>Update time zone database</b> The inverter is updating the time zone database.</p>
7354	<p><b>⚠ QUALIFIED PERSON</b></p> <p><b>Update of time zone database not successful</b> The update of the time zone database failed.</p> <p><b>Corrective measures:</b></p> <ul style="list-style-type: none"> <li>• Retry update.</li> <li>• If this message is displayed again, contact the Service (see Section 15 "Contact", page 96).</li> </ul>
7355	<p><b>Update WebUI</b> The inverter is updating the inverter user interface.</p>

Event number	Message, cause and corrective measures
7356	<p data-bbox="311 183 593 215"><b>⚠ QUALIFIED PERSON</b></p> <p data-bbox="288 231 655 263"><b>Update of the WebUI not successful</b></p> <p data-bbox="288 268 716 300">The update of the inverter user interface failed.</p> <p data-bbox="288 304 509 336"><b>Corrective measures:</b></p> <ul data-bbox="311 341 985 438" style="list-style-type: none"> <li data-bbox="311 341 464 373">• Retry update.</li> <li data-bbox="311 378 985 438">• If this message is displayed again, contact the Service (see Section 15 "Contact", page 96).</li> </ul>
7500 to 7501	<p data-bbox="311 446 593 478"><b>⚠ QUALIFIED PERSON</b></p> <p data-bbox="288 494 744 526"><b>Fan fault &gt; Check inverter electronic and fan</b></p>
7619	<p data-bbox="311 542 593 574"><b>⚠ QUALIFIED PERSON</b></p> <p data-bbox="288 590 1002 622"><b>Communication fault with meter unit &gt; Check communication to meter</b></p> <p data-bbox="288 627 840 659">The inverter is not receiving any data from the energy meter.</p> <p data-bbox="288 663 509 695"><b>Corrective measures:</b></p> <ul data-bbox="311 700 991 853" style="list-style-type: none"> <li data-bbox="311 700 935 758">• Ensure that the energy meter is correctly integrated into the same network as the inverter (see energy meter manual).</li> <li data-bbox="311 762 991 853">• For WLAN connection: Improve the WLAN connection quality (e.g. via WLAN repeater) or connect the inverter with the DHCP server (router) via Ethernet.</li> </ul>
7702	<p data-bbox="311 861 593 893"><b>⚠ QUALIFIED PERSON</b></p> <p data-bbox="288 909 487 941"><b>Interference device</b></p> <p data-bbox="288 946 711 978">The cause must be determined by the Service.</p> <p data-bbox="288 983 509 1015"><b>Corrective measures:</b></p> <ul data-bbox="311 1019 868 1053" style="list-style-type: none"> <li data-bbox="311 1019 868 1053">• Contact the Service (see Section 15 "Contact", page 96).</li> </ul>
8003	<p data-bbox="311 1061 593 1093"><b>⚠ QUALIFIED PERSON</b></p> <p data-bbox="288 1109 599 1141"><b>Active power limited derating</b></p> <p data-bbox="288 1145 1002 1203">The inverter has reduced its power output for more than ten minutes due to excessive temperature.</p> <p data-bbox="288 1208 509 1240"><b>Corrective measures:</b></p> <ul data-bbox="311 1244 991 1423" style="list-style-type: none"> <li data-bbox="311 1244 991 1302">• Clean the cooling fins on the rear of the enclosure and the air ducts on the top using a soft brush.</li> <li data-bbox="311 1307 778 1339">• Ensure that the inverter has sufficient ventilation.</li> <li data-bbox="311 1343 974 1375">• Ensure that the ambient temperature +40°C has not been exceeded.</li> <li data-bbox="311 1380 924 1423">• Ensure that the inverter is not exposed to direct solar irradiation.</li> </ul>



Event number	Message, cause and corrective measures
8101 to 8104	<p data-bbox="311 183 599 220"><b>⚠ QUALIFIED PERSON</b></p> <p data-bbox="288 231 554 263"><b>Communication disturbed</b></p> <p data-bbox="288 268 711 300">The cause must be determined by the Service.</p> <p data-bbox="288 304 509 336"><b>Corrective measures:</b></p> <ul data-bbox="311 341 868 373" style="list-style-type: none"> <li data-bbox="311 341 868 373">• Contact the Service (see Section 15 "Contact", page 96).</li> </ul>
9002	<p data-bbox="311 383 599 419"><b>⚠ QUALIFIED PERSON</b></p> <p data-bbox="288 430 599 462"><b>SMA Grid Guard code invalid</b></p> <p data-bbox="288 467 1012 531">The SMA Grid Guard code entered is incorrect. The operating parameters are still protected and cannot be changed.</p> <p data-bbox="288 536 509 568"><b>Corrective measures:</b></p> <ul data-bbox="311 572 722 604" style="list-style-type: none"> <li data-bbox="311 572 722 604">• Enter the correct SMA Grid Guard code.</li> </ul>
9003	<p data-bbox="288 606 532 638"><b>Grid parameter locked</b></p> <p data-bbox="288 643 1012 722">Changes to the grid parameters are now blocked. In order to be able to make changes to the grid parameters, from now on you must log in using the SMA Grid Guard code.</p>
9005	<p data-bbox="311 742 599 778"><b>⚠ QUALIFIED PERSON</b></p> <p data-bbox="288 790 924 821"><b>Changing of grid parameters not possible &gt; Ensure DC supply</b></p> <p data-bbox="288 826 666 858">This error can have the following causes:</p> <ul data-bbox="311 863 968 927" style="list-style-type: none"> <li data-bbox="311 863 756 895">• The parameters to be changed are protected.</li> <li data-bbox="311 900 968 932">• The DC voltage at the DC input is not sufficient to run the main CPU.</li> </ul> <p data-bbox="288 938 509 970"><b>Corrective measures:</b></p> <ul data-bbox="311 975 946 1070" style="list-style-type: none"> <li data-bbox="311 975 655 1007">• Enter the SMA Grid Guard code.</li> <li data-bbox="311 1011 946 1070">• Ensure that at least the DC start voltage is available (green LED is flashing, pulsing or glowing).</li> </ul>
9007	<p data-bbox="311 1085 599 1121"><b>⚠ QUALIFIED PERSON</b></p> <p data-bbox="288 1133 431 1165"><b>Abort self-test</b></p> <p data-bbox="288 1169 655 1201">The self-test (Italy only) was terminated.</p> <p data-bbox="288 1206 509 1238"><b>Corrective measures:</b></p> <ul data-bbox="311 1243 711 1307" style="list-style-type: none"> <li data-bbox="311 1243 711 1275">• Ensure that the AC connection is correct.</li> <li data-bbox="311 1279 520 1307">• Restart the self-test.</li> </ul>
10108	<b>Time adjusted / old time</b>
10109	<b>Time adjusted / new time</b>

Event number	Message, cause and corrective measures
10110	<p><b>⚠ QUALIFIED PERSON</b></p> <p><b>Time synchronization failed: [tn0]</b></p> <p>No time information could be called up from the set NTP server.</p> <p><b>Corrective measures:</b></p> <ul style="list-style-type: none"> <li>• Ensure that the NTP server was configured correctly.</li> <li>• Ensure that the inverter is integrated into a local network with Internet connection.</li> </ul>
10118	<p><b>Parameter upload complete</b></p> <p>The configuration file was loaded successfully.</p>
10248	<p><b>⚠ QUALIFIED PERSON</b></p> <p><b>[Interface]: network busy</b></p> <p>The network is busy. Data exchange between the devices is not at an optimum and is greatly delayed.</p> <p><b>Corrective measures:</b></p> <ul style="list-style-type: none"> <li>• Increase the query intervals.</li> <li>• If necessary, reduce the number of devices in the network.</li> </ul>
10249	<p><b>⚠ QUALIFIED PERSON</b></p> <p><b>[Interface]: network overloaded</b></p> <p>The network is overloaded. There is no data exchange between the devices.</p> <p><b>Corrective measures:</b></p> <ul style="list-style-type: none"> <li>• Reduce the number of devices in the network.</li> <li>• If necessary, increase the data query intervals.</li> </ul>
10250	<p><b>⚠ QUALIFIED PERSON</b></p> <p><b>[Interface]: package error rate [ok / high]</b></p> <p>The package error rate has changed. If the package error rate is high, the network is overloaded or the connection to the network switch or DHCP server (router) is disturbed.</p> <p><b>Corrective measures if the package error rate is high:</b></p> <ul style="list-style-type: none"> <li>• Ensure that with an Ethernet connection, the network cable and the network connector are not damaged and that the network connectors are correctly plugged.</li> <li>• If necessary, increase the data query intervals.</li> <li>• If necessary, reduce the number of devices in the network.</li> </ul>

Event number	Message, cause and corrective measures
10251	<p><b>[Interface]: communication status goes to [OK / Warning / Error / Not connected]</b></p> <p>The communication status to the network switch or DHCP server (router) has changed. An additional error message may be displayed.</p>
10252	<p><b>⚠ QUALIFIED PERSON</b></p> <p><b>[Interface]: communication disrupted</b></p> <p>There is no valid signal on the network line.</p> <p><b>Corrective measures:</b></p> <ul style="list-style-type: none"> <li>• Ensure that with an Ethernet connection, the network cable and the network connector are not damaged and that the network connectors are correctly plugged.</li> <li>• Ensure that the DHCP server (router) and any network switches are signaling correct operation.</li> </ul>
10253	<p><b>⚠ QUALIFIED PERSON</b></p> <p><b>[Interface]: connection speed goes to [100 Mbit / 10 Mbit]</b></p> <p>The data transfer rate has changed. The cause for the status [10 Mbit] can be a defective plug, a defective cable or the pulling or plugging of the network connector.</p> <p><b>Corrective measures if the status is [10 Mbit]:</b></p> <ul style="list-style-type: none"> <li>• Ensure that with an Ethernet connection, the network cable and the network connector are not damaged and that the network connectors are correctly plugged.</li> <li>• Ensure that the DHCP server (router) and any network switches are signaling correct operation.</li> </ul>
10254	<p><b>⚠ QUALIFIED PERSON</b></p> <p><b>[Interface]: duplex mode goes to [Full / Half]</b></p> <p>The duplex mode (data transfer mode) has changed. The cause for the status [Half] can be a defective plug, a defective cable or the pulling or plugging of the network connector.</p> <p><b>Corrective measures if the status is [Half]:</b></p> <ul style="list-style-type: none"> <li>• Ensure that with an Ethernet connection, the network cable and the network connector are not damaged and that the network connectors are correctly plugged.</li> <li>• Ensure that the DHCP server (router) and any network switches are signaling correct operation.</li> </ul>

Event number	Message, cause and corrective measures
10255	<p><b>⚠ QUALIFIED PERSON</b></p> <p><b>[Interface]: Network load OK</b></p> <p>The network load has returned to a normal range after being busy.</p>
10282	<p><b>[User group]-Login via [protocol] locked</b></p> <p>After several incorrect login attempts, login has been blocked for a limited time. In this case, the User login will be blocked for 15 minutes, the Grid Guard login for 12 hours.</p> <p><b>Corrective measures:</b></p> <ul style="list-style-type: none"> <li>• Wait until the given time has expired and then retry login.</li> </ul>
10283	<p><b>⚠ QUALIFIED PERSON</b></p> <p><b>WLAN module faulty</b></p> <p>The WLAN module integrated in the inverter is defective.</p> <p><b>Corrective measures:</b></p> <ul style="list-style-type: none"> <li>• Contact the Service (see Section 15 "Contact", page 96).</li> </ul>
10284	<p><b>⚠ QUALIFIED PERSON</b></p> <p><b>No WLAN connection possible</b></p> <p>The inverter does not currently have a WLAN connection to the selected network.</p> <p><b>Corrective measures:</b></p> <ul style="list-style-type: none"> <li>• Ensure that the SSID, the WLAN password and the encryption method have been entered correctly. The encryption method is specified by your WLAN router or WLAN Access Point and can be changed there.</li> <li>• Ensure that the WLAN router or WLAN Access Point is in range and is signaling correct operation.</li> <li>• If this message is displayed often, improve the WLAN connection by using a WLAN repeater.</li> </ul>
10285	<p><b>WLAN connection established</b></p> <p>Connection to the selected WLAN network has been established.</p>

Event number	Message, cause and corrective measures
10286	<p><b>⚠ QUALIFIED PERSON</b></p> <p><b>WLAN connection lost</b> The inverter has lost WLAN connection to the selected network.</p> <p><b>Corrective measures:</b></p> <ul style="list-style-type: none"> <li>• Ensure that the WLAN router or WLAN Access Point is still active.</li> <li>• Ensure that the WLAN router or WLAN Access Point is in range and is signaling correct operation.</li> <li>• If this message is displayed often, improve the WLAN connection by using a WLAN repeater.</li> </ul>
10339	<p><b>Webconnect enabled</b> The Webconnect function has been activated.</p>
10340	<p><b>Webconnect disabled</b> The Webconnect function has been deactivated.</p>
10341	<p><b>Webconnect error: no connection</b> No connection to Sunny Portal possible.</p> <p><b>Corrective measures:</b></p> <ul style="list-style-type: none"> <li>• Ensure that the Internet connection is working properly.</li> <li>• Ensure that the Webconnect function is activated.</li> <li>• Ensure that the network cable at the inverter is correctly connected.</li> </ul>
10343	<p><b>Webconnect error: Default gateway not configured</b> The standard gateway was not configured.</p> <p><b>Corrective measures:</b></p> <ul style="list-style-type: none"> <li>• Configure the standard gateway.</li> </ul>
10344	<p><b>Webconnect error: DNS server not configured</b> DNS server was not configured.</p> <p><b>Corrective measures:</b></p> <ul style="list-style-type: none"> <li>• Configure DNS server.</li> </ul>
10345	<p><b>Webconnect error: No reply to DNS request [xx]</b> DNS server not available</p> <p><b>Corrective measures:</b></p> <ul style="list-style-type: none"> <li>• Ensure that the address of the DNS server has been entered correctly.</li> <li>• Ensure that the network cable at the inverter is correctly connected.</li> </ul>

Event number	Message, cause and corrective measures
10346	<p><b>Webconnect error: Unknown SIP proxy [xx]</b> SIP-Proxy not available.</p> <p><b>Corrective measures:</b></p> <ul style="list-style-type: none"> <li>• Ensure that the network cable at the inverter is correctly connected.</li> </ul>
10347	<p><b>Webconnect error: Unknown STUN server [xx]</b> STUN server not available.</p> <p><b>Corrective measures:</b></p> <ul style="list-style-type: none"> <li>• Ensure that the network cable at the inverter is correctly connected.</li> </ul>
10348	<p><b>Webconnect error: No reply to request to STUN server</b> STUN server not available.</p> <p><b>Corrective measures:</b></p> <ul style="list-style-type: none"> <li>• Ensure that the network cable at the inverter is correctly connected.</li> <li>• Check the configuration of the router.</li> </ul>
10349	<p><b>Webconnect error: No reply to SIP option packs</b> SIP server not available.</p> <p><b>Corrective measures:</b></p> <ul style="list-style-type: none"> <li>• Check the configuration of the router.</li> </ul>
10350	<p><b>Webconnect error: Registration rejected by SIP registrar</b> The inverter is not registered in Sunny Portal.</p> <p><b>Corrective measures:</b></p> <ul style="list-style-type: none"> <li>• Contact the Service (see Section 15 "Contact", page 96).</li> </ul>
10351	<p><b>Webconnect error: Unknown SIP registrar [xx]</b> SIP Registrar not available.</p> <p><b>Corrective measures:</b></p> <ul style="list-style-type: none"> <li>• Ensure that the network cable at the inverter is correctly connected.</li> <li>• Check the configuration of the router.</li> </ul>
10352	<p><b>Webconnect error: Faulty communication</b> No connection to Sunny Portal possible.</p> <p><b>Corrective measures:</b></p> <ul style="list-style-type: none"> <li>• Ensure that the Internet connection is working properly.</li> <li>• Ensure that the Webconnect function is activated.</li> <li>• Ensure that the network cable at the inverter is correctly connected.</li> </ul>

Event number	Message, cause and corrective measures
10353	<p><b>Webconnect error: registration of the SIP registry has not responded</b> SIP Registrar not fully available.</p> <p><b>Corrective measures:</b></p> <ul style="list-style-type: none"> <li>• Ensure that the network cable at the inverter is correctly connected.</li> <li>• Check the configuration of the router.</li> </ul>
10502	<p><b>Active power limited AC frequency</b> The inverter has reduced its power due to a too-high power frequency to ensure grid stability.</p> <p><b>Corrective measures:</b></p> <ul style="list-style-type: none"> <li>• If possible, check the power frequency and observe how often fluctuations occur. If fluctuations occur frequently and this message is displayed often, contact the grid operator and request approval to change the operating parameters of the inverter. If the grid operator gives his approval, discuss any changes to the operating parameters with Service (see Section 15 "Contact", page 96).</li> </ul>
10901	<p><b>Start self-test [xx]</b> The self-test is running.</p>
10902	<p><b>Uac RPro [xxx] V</b> Preliminary result of the self-test</p>
10903	<p><b>Uac Max [xxx] V</b> Preliminary result of the self-test</p>
10904	<p><b>Uac Min [xxx] V</b> Preliminary result of the self-test</p>
10905	<p><b>Uac Min Fast [xxx] V</b> Preliminary result of the self-test</p>
10906	<p><b>Fac SwMax [xxx] Hz</b> Preliminary result of the self-test</p>
10907	<p><b>Fac SwMin [xxx] Hz</b> Preliminary result of the self-test</p>
10908	<p><b>Fac Max [xxx] Hz</b> Preliminary result of the self-test</p>
10909	<p><b>Fac Min [xxx] Hz</b> Preliminary result of the self-test</p>
10910	<p><b>Disconn. threshold [xxx] [xx]</b> Preliminary result of the self-test</p>

Event number	Message, cause and corrective measures
10911	<b>Stand. Val. [xxx] [xx]</b> Preliminary result of the self-test
10912	<b>Disconn. time [xx] s</b> Preliminary result of the self-test
27103	<b>Set parameter</b> The parameter changes are being adopted.
27104	<b>Parameters set successfully</b> The parameter changes were successfully adopted.
27107	<b>Update file OK</b> The update file found is valid.
27301	<b>Update communication</b> The inverter is updating the communication component.
27302	<b>Update main CPU</b> The inverter is updating the inverter component.
27312	<b>Update completed</b> The inverter has successfully completed the update.
29001	<b>Inst. code valid</b> The entered Grid Guard code is valid. Protected parameters have now been unlocked and you can adjust the parameters. The parameters will be automatically locked again after ten feed-in hours.
29004	<b>Grid parameters unchanged</b> Changing the grid parameters is not possible.

## 12.3 Checking the PV System for Ground Faults

### QUALIFIED PERSON

If the red LED is glowing and the event number 3501, 3601 or 3701 is being displayed in the **Results** menu on the inverter user interface, there may be a ground fault present. The electrical insulation from the PV system to ground is defective or insufficient.

### WARNING

#### Danger to life due to electric shock

In the event of a ground fault, high voltages can be present.

- Touch the cables of the PV array on the insulation only.
- Do not touch any parts of the substructure or frame of the PV array.
- Do not connect PV strings with ground faults to the inverter.



**NOTICE****Destruction of the measuring device due to overvoltage**

- Only use measuring devices with a DC input voltage range of 1000 V or higher.

**Procedure:**

In order to check the PV system for ground faults, perform the following actions in the prescribed order. The exact procedure is described in the following sections.

- Check the PV system for ground faults by measuring the voltage.
- If the voltage measurement was not successful, check the PV system via insulation resistance measurement for ground faults.

**Test by Measuring the Voltage**

Proceed as follows to check each string in the PV system for ground faults.

**Procedure:**

1.  **DANGER**

**Danger to life due to high voltages**

- Disconnect the inverter from all voltage sources (see Section 10, page 60).

2. Measure the voltages:

- Measure the voltage between the positive terminal and the ground potential (PE).
- Measure the voltage between the negative terminal and the ground potential (PE).
- Measure the voltage between the positive and negative terminals.

If the following results are present at the same time, there is a ground fault in the PV system:

- All measured voltages are stable.
- The sum of the two voltages to ground potential is approximately equal to the voltage between the positive and negative terminals.
- If a ground fault is present, determine the location of the ground fault via the ratio of the two measured voltages and eliminate the ground fault.

**Example: Location of the ground fault**

The example shows a ground fault between the second and third PV module.

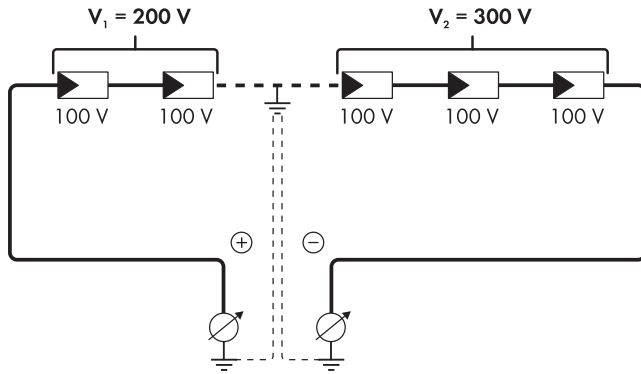

3. If a definite ground fault cannot be measured and the message is still displayed, measure the insulation resistance.
4. Reconnect the strings without ground faults to the inverter and recommission the inverter.

**Test by Measuring the Insulation Resistance**

If the voltage measurement does not provide sufficient evidence of a ground fault, the insulation resistance measurement can provide more exact results.

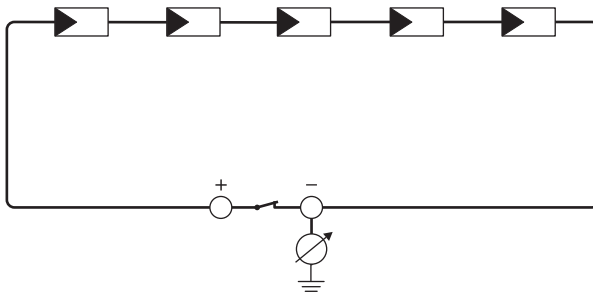

Figure 12: Schematic diagram of the measurement

### Calculating the insulation resistance

The expected total resistance of the PV system or of an individual string can be calculated using the following formula:

$$\frac{1}{R_{\text{total}}} = \frac{1}{R_1} + \frac{1}{R_2} + \frac{1}{R_3} + \dots$$

The exact insulation resistance of a PV module can be obtained from the module manufacturer or the datasheet.

For the resistance of a PV module an average value can be assumed: for thin-film PV modules approximately 40 MΩ and for polycrystalline and monocrystalline PV modules approximately 50 MΩ per PV module (for further information on calculating the insulation resistance see the Technical Information "Insulation Resistance (Riso) of Non-Galvanically Isolated PV Systems" at [www.SMA-Solar.com](http://www.SMA-Solar.com)).

#### Required devices:

- Suitable device for safe disconnection and short-circuiting
- Measuring device for insulation resistance

### Device required for safe disconnection and short-circuiting of the PV array

The insulation resistance can only be measured with a suitable device for safe disconnection and short-circuiting of the PV array. If no suitable device is available, the insulation measurement must not be carried out.

#### Procedure:

1. Calculate the expected insulation resistance per string.

2.  **DANGER**

#### Danger to life due to high voltages

- Disconnect the inverter from all voltage sources (see Section 10, page 60).

3. Install the short circuit device.

4. Connect the measuring device for insulation resistance.

5. Short-circuit the first string.

6. Set the test voltage. The test voltage should be as close as possible to the maximum system voltage of the PV modules but must not exceed it (see datasheet of the PV modules).

7. Measure the insulation resistance.

8. Eliminate the short circuit.

9. Measure the remaining strings in the same manner.

- If the insulation resistance of a string deviates considerably from the theoretically calculated value, there is a ground fault present in that string.

10. Reconnect to the inverter only those strings from which the ground fault has been eliminated.

11. Reconnect all other strings to the inverter.

12. Recommission the inverter.
13. If the inverter still displays an insulation error, contact the Service (see Section 15 "Contact", page 96). The PV modules might not be suitable for the inverter in the present quantity.

## 12.4 Updating the Firmware

### QUALIFIED PERSON

If there is not an automatic update enabled for the inverter in the communication product (e.g. Sunny Home Manager) or in Sunny Portal, you can update the inverter firmware as described in the following.

#### Requirements:

- An update file with the desired inverter firmware must be available. The update file is, for example, available for download on the product page of the inverter at [www.SMA-Solar.com](http://www.SMA-Solar.com).

#### Procedure:

1. Activate the user interface (see Section 8.1, page 44).
2. Log into the user interface (see Section 8.2, page 47).
3. Select the menu **Device Configuration**.
4. Select [**Settings**].
5. In the subsequent context menu, select [**Updating the firmware**].
6. Follow the instructions in the dialog.

## 13 Decommissioning the Inverter

### ⚠ QUALIFIED PERSON

To decommission the inverter completely upon completion of its service life, proceed as described in this Section.

### ⚠ CAUTION

#### Risk of injury when lifting the inverter, or if it is dropped

The inverter weighs 16 kg. There is risk of injury if the inverter is lifted incorrectly or dropped while being transported or when attaching it to or removing it from the wall mounting bracket.

- Transport and lift the inverter carefully.

#### Procedure:

#### 1. ⚠ DANGER

##### Danger to life due to high voltages

- Disconnect the inverter from all voltage sources (see Section 10, page 60).

#### 2. ⚠ CAUTION

##### Risk of burns due to hot enclosure parts

- Wait 30 minutes for the enclosure to cool down.

3. Unscrew the swivel nut from the threaded sleeve for the network cable.

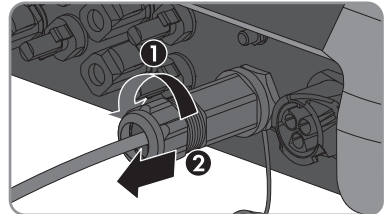

4. Unscrew and remove the threaded sleeve from the network port thread on the inverter.

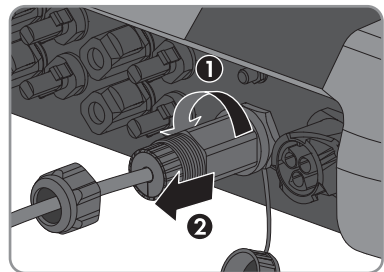

5. Release the network cable plug and pull it out of the jack on the inverter.

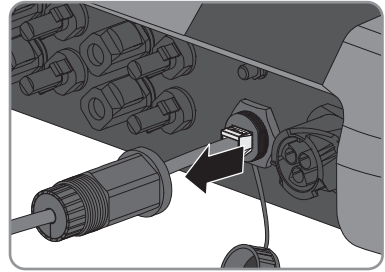

6. Take the cable support sleeve out of the threaded sleeve and remove the network cable from the cable support sleeve.

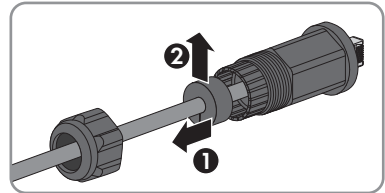

7. Lead the network cable out of the threaded sleeve and the swivel nut.

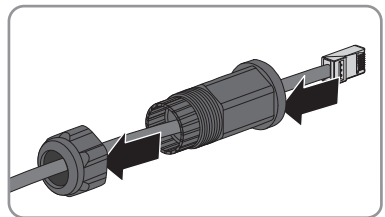

8. Screw the protective cap onto the network port.

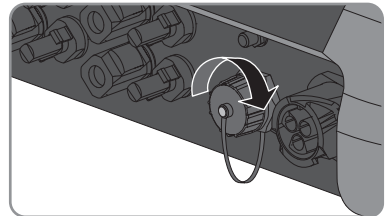

9. Unscrew and remove the antenna.

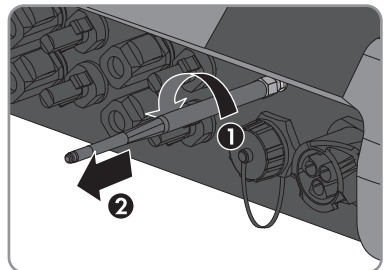

10. If there is a protective cap available, plug the protective cap onto the jack for connecting the antenna.

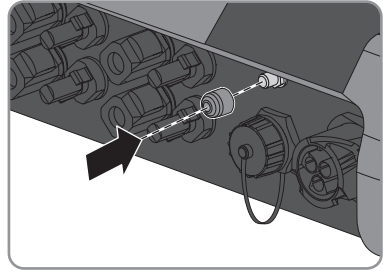

11. If an additional grounding or an equipotential bonding is connected to the inverter, remove the pan head screw M5x12 using a Torx screwdriver (TX 25) and remove the grounding cable.

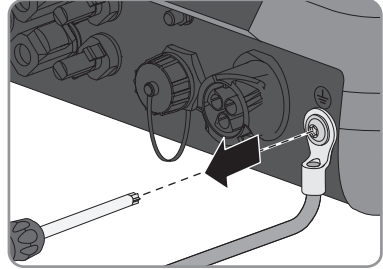

12. Using a Torx screwdriver (TX 25), unscrew the left- and right-hand pan head screws M5x12 used to secure the inverter to the wall mounting bracket.

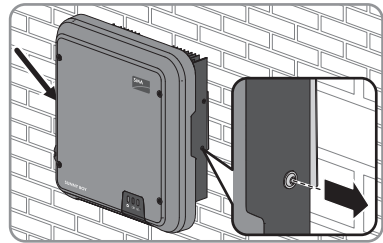

13. Remove the inverter by lifting it vertically up and off the wall mounting bracket.



14. Unscrew the screws for fastening the wall mounting bracket and remove the wall mounting bracket.

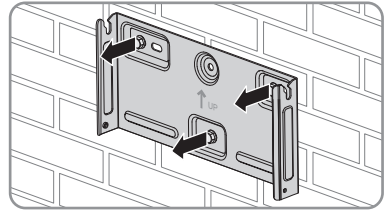

15. If the inverter is to be stored or shipped, pack the inverter, the AC connector, the DC connector, the RJ45 protective sleeve, the antenna and the wall mounting bracket. Use the original packaging or packaging that is suitable for the weight and dimensions of the inverter.
16. Dispose of the inverter in accordance with the locally applicable disposal regulations for electronic waste.



## 14 Technical Data

### 14.1 DC/AC

#### 14.1.1 Sunny Boy 3.0 / 3.6

##### DC Input

	<b>SB3.0-1AV-40</b>	<b>SB3.6-1AV-40</b>
Maximum DC power at $\cos \varphi = 1$	3200 W	3880 W
Maximum input voltage	600 V	600 V
MPP voltage range	110 V to 500 V	130 V to 500 V
Rated input voltage	365 V	365 V
Minimum usable input voltage	100 V	100 V
Initial input voltage	125 V	125 V
Maximum input current, input A	15 A	15 A
Maximum input current, input B	15 A	15 A
Maximum input current per string, input A	15 A	15 A
Maximum input current per string, input B	15 A	15 A
Maximum short-circuit current, input A*	20 A	20 A
Maximum short-circuit current, input B*	20 A	20 A
Maximum reverse current from the inverter in the system for max. 1 ms	0 A	0 A
Number of independent MPP inputs	2	2
Strings per MPP input	2	2
Overvoltage category in accordance with IEC 60664-1	II	II

\* In accordance with IEC 62109-2: ISC PV

## AC Output

	<b>SB3.0-1AV-40</b>	<b>SB3.6-1AV-40</b>
Rated power at 230 V, 50 Hz	3000 W	3680 W
Maximum apparent AC power at $\cos \varphi = 1$	3000 VA	3680 VA
Rated grid voltage	230 V	230 V
Nominal AC voltage	220 V / 230 V / 240 V	220 V / 230 V / 240 V
AC voltage range*	180 V to 280 V	180 V to 280 V
Nominal AC current at 220 V	13.7 A	16 A
Nominal AC current at 230 V	13 A	16 A
Nominal AC current at 240 V	12.5 A	15.4 A
Maximum output current	16 A	16 A
Total harmonic distortion of the output current with total harmonic distortion of the AC voltage < 2%, and AC power > 50% of the rated power	≤ 3%	≤ 3%
Maximum output current under fault conditions	29 A	29 A
Inrush current	< 20% of the nominal AC current for a maximum of 10 ms	< 20% of the nominal AC current for a maximum of 10 ms
Rated power frequency	50 Hz	50 Hz
AC power frequency*	50 Hz / 60 Hz	50 Hz / 60 Hz
Operating range at AC power frequency 50 Hz	45 Hz to 55 Hz	45 Hz to 55 Hz
Operating range at AC power frequency 60 Hz	55 Hz to 65 Hz	55 Hz to 65 Hz
Power factor at rated power	1	1
Displacement power factor $\cos \varphi$ , adjustable	0.8 overexcited to 0.8 underexcited	0.8 overexcited to 0.8 underexcited
Feed-in phases	1	1
Phase connection	1	1
Overvoltage category in accordance with IEC 60664-1	III	III

\* Depending on the configured country data set

## Efficiency

	SB3.0-1AV-40	SB3.6-1AV-40
Maximum efficiency, $\eta_{\max}$	97.0%	97.0%
European weighted efficiency, $\eta_{\text{EU}}$	96.4%	96.5%

## 14.1.2 Sunny Boy 4.0 / 5.0

### DC Input

	SB4.0-1AV-40	SB5.0-1AV-40
Maximum DC power at $\cos \varphi = 1$ *	4200 W	5250 W
Maximum input voltage	600 V	600 V
MPP voltage range	140 V to 500 V	175 V to 500 V
Rated input voltage	365 V	365 V
Minimum usable input voltage	100 V	100 V
Initial input voltage	125 V	125 V
Maximum input current, input A	15 A	15 A
Maximum input current, input B	15 A	15 A
Maximum input current per string, input A	15 A	15 A
Maximum input current per string, input B	15 A	15 A
Maximum short-circuit current, input A **	20 A	20 A
Maximum short-circuit current, input B **	20 A	20 A
Maximum reverse current from the inverter in the system for max. 1 ms	0 A	0 A
Number of independent MPP inputs	2	2
Strings per MPP input	2	2
Overvoltage category in accordance with IEC 60664-1	II	II

\* According to VDE-AR-N 4105, the maximum DC power at  $\cos \varphi = 1$  of the SB5.0-1AV-40 is 4825 W

\*\* In accordance with IEC 62109-2: ISC PV

### AC Output

	SB4.0-1AV-40	SB5.0-1AV-40
Rated power at 230 V, 50 Hz *	4000 W	5000 W
Maximum apparent AC power at $\cos \varphi = 1$ **	4000 VA	5000 VA
Rated grid voltage	230 V	230 V

	<b>SB4.0-1AV-40</b>	<b>SB5.0-1AV-40</b>
Nominal AC voltage	220 V / 230 V / 240 V	220 V / 230 V / 240 V
AC voltage range***	180 V to 280 V	180 V to 280 V
Nominal AC current at 220 V	18.2 A	22 A
Nominal AC current at 230 V	17.4 A	22 A
Nominal AC current at 240 V	16.7 A	21 A
Maximum output current****	22 A	22 A
Total harmonic distortion of the output current with total harmonic distortion of the AC voltage < 2%, and AC power > 50% of the rated power	≤ 3%	≤ 3%
Maximum output current under fault conditions	29 A	29 A
Inrush current	< 20% of the nominal AC current for a maximum of 10 ms	< 20% of the nominal AC current for a maximum of 10 ms
Rated power frequency	50 Hz	50 Hz
AC power frequency***	50 Hz / 60 Hz	50 Hz / 60 Hz
Operating range at AC power frequency 50 Hz	45 Hz to 55 Hz	45 Hz to 55 Hz
Operating range at AC power frequency 60 Hz	55 Hz to 65 Hz	55 Hz to 65 Hz
Power factor at rated power	1	1
Displacement power factor cos φ, adjustable	0.8 overexcited to 1 to 0.8 underexcited	0.8 overexcited to 1 to 0.8 underexcited
Feed-in phases	1	1
Phase connection	1	1
Overvoltage category in accordance with IEC 60664-1	III	III

\* According to VDE-AR-N 4105, the rated power at 230 V, 50 Hz of the SB5.0-1AV-40 is 4600 W

\*\* According to VDE-AR-N 4105, the rated power at 230 V, 50 Hz of the SB5.0-1AV-40 is 4600 VA

\*\*\* Depending on the configured country data set

\*\*\*\* According to AS 4777, the maximum output current is 21.7 A

## Efficiency

	<b>SB4.0-1AV-40</b>	<b>SB5.0-1AV-40</b>
Maximum efficiency, $\eta_{\max}$	97.0%	97.0%
European weighted efficiency, $\eta_{\text{EU}}$	96.5%	96.5%

## 14.2 General Data

Width x height x depth	435 mm x 470 mm x 176 mm
Weight	16 kg
Length x width x height of the packaging	495 mm x 595 mm x 250 mm
Transport weight	20.5 kg
Climatic category in accordance with IEC 60721-3-4	4K4H
Environmental category	Outdoors
Pollution degree outside the enclosure	3
Pollution degree inside the enclosure	2
Operating temperature range	-25 °C to +60 °C
Maximum permissible value for relative humidity, non-condensing	100%
Maximum operating altitude above mean sea level (MSL)	3000 m
Typical noise emission	25 dB(A)
Power loss in night mode	2 W
Maximum data volume per inverter with Speedwire/Webconnect	550 MB/month
Additional data volume when using the Sunny Portal live interface	660 kB/hour
Topology	Transformerless
Cooling method	Convection
Degree of protection for electronics in accordance with IEC 60529	IP65
Protection class in accordance with IEC 61140	I

Grid configurations*	IT, Delta-IT, TN-C, TN-S, TN-C-S, TT (when $V_{N,PE} < 20 \text{ V}$ )
Approvals and national standards, as per 02/2017**	AS 4777, C10/11, CE, CEI 0-21, DIN EN 62109 / IEC 62109, EN 50438, G59/3, G83/2, NEN EN 50438, RD1699, SI 4777, UTE C15-712, VDE0126-1-1, VDE-AR-N 4105, VFR 2014

\* **IT, Delta-IT:** When using in these systems, the grounding conductor monitoring must be deactivated and an additional grounding connected to the inverter.

\*\* **AS 4777:** If DRM support is specified, the inverter may only be used in conjunction with a Demand Response Enabling Device (DRED).

**EN 50438:** does not apply to all national appendices of EN 50438

**IEC 62109-2:** This standard requires that the inverter is connected to Sunny Portal and that the fault alert is activated in Sunny Portal.

**NRS 97-2-1:** This standard requires a separate label attached to the AC distribution board which indicates the AC-side disconnection of the inverter in case of a grid failure (for further details, see NRS 97-2-1, Sect. 4.2.7.1 and 4.2.7.2)

## 14.3 Climatic Conditions

### Installation in accordance with IEC 60721-3-3, Class 4K4H

Extended temperature range	-25 °C to +60 °C
Extended humidity range	0% to 100%
Extended air pressure range	79.5 kPa to 106 kPa

### Transport in accordance with IEC 60721-3-2, Class 2K3

Temperature range	-25 °C to +70 °C
-------------------	------------------

## 14.4 Protective Devices

DC reverse polarity protection	Short-circuit diode
Input-side disconnection point	DC load-break switch
AC short-circuit current capability	Current control
Grid monitoring	SMA Grid Guard 6
Maximum permissible fuse protection	32 A
Ground fault monitoring	Insulation monitoring: $R_{iso} > 200 \text{ k}\Omega$
All-pole sensitive residual-current monitoring unit	Available

## 14.5 Equipment

DC connection	SUNCLIX DC connector
---------------	----------------------

AC connection	AC connector
WLAN	As standard
SMA Speedwire/Webconnect	As standard

## 14.6 Torques

Screws for securing the inverter to the wall mounting bracket	2.5 Nm
Screw terminals of the AC connector	1.4 Nm
Additional grounding	2.5 Nm
SUNCLIX swivel nut	2.0 Nm

## 14.7 Data Storage Capacity

Energy yields in the course of the day	63 days
Daily yields	30 years
Event messages for users	1024 events
Event messages for installers	1024 events

## 15 Contact

If you have technical problems with our products, please contact the SMA Service Line. We require the following information in order to provide you with the necessary assistance:

- Inverter device type
- Inverter serial number
- Inverter firmware version
- Special country-specific settings of the inverter (if applicable)
- Type and number of PV modules connected
- Mounting location and altitude of the inverter
- Inverter message
- Optional equipment, e.g. communication products
- If necessary, system name in the Sunny Portal
- If necessary, access data in the Sunny Portal

Danmark	SMA Solar Technology AG	Belgien	SMA Benelux BVBA/SPRL
Deutschland	Niestetal	Belgique	Mechelen
Österreich	Sunny Boy, Sunny Mini Central,	België	+32 15 286 730
Schweiz	Sunny Tripower: +49 561 9522-1499	Luxemburg	SMA Online Service Center: www.SMA-Service.com
	Monitoring Systems (Kommunikationsprodukte): +49 561 9522-2499	Luxembourg	
	Fuel Save Controller (PV-Diesel-Hybridsysteme): +49 561 9522-3199	Nederland	
	Sunny Island, Sunny Boy Storage, Sunny Backup, Hydro Boy: +49 561 9522-399	Česko	SMA Service Partner TERMS a.s.
	Sunny Central, Sunny Central Storage: +49 561 9522-299	Magyarország	+420 387 6 85 111
	SMA Online Service Center: www.SMA-Service.com	Slovensko	SMA Online Service Center: www.SMA-Service.com
France	SMA France S.A.S. Lyon +33 472 22 97 00	Türkiye	SMA Service Partner DEKOM Ltd. Şti. +90 24 22430605
	SMA Online Service Center : www.SMA-Service.com	Ελλάδα	SMA Service Partner AKTOR FM. Αθήνα
		Κύπρος	+30 210 8184550 SMA Online Service Center: www.SMA-Service.com



<p>España Portugal</p>	<p>SMA Ibérica Tecnología Solar, S.L.U. Barcelona +34 935 63 50 99 SMA Online Service Center: www.SMA-Service.com</p>	<p>United Kingdom</p>	<p>SMA Solar UK Ltd. Milton Keynes +44 1908 304899 SMA Online Service Center: www.SMA-Service.com</p>
<p>Italia</p>	<p>SMA Italia S.r.l. Milano +39 02 8934-7299 SMA Online Service Center: www.SMA-Service.com</p>	<p>Bulgaria România Slovenija Hrvatska</p>	<p>SMA Service Partner Renovatio Solar +40 372 756 599 SMA Online Service Center: www.SMA-Service.com</p>
<p>United Arab Emirates</p>	<p>SMA Middle East LLC Abu Dhabi +971 2234 6177 SMA Online Service Center: www.SMA-Service.com</p>	<p>India</p>	<p>SMA Solar India Pvt. Ltd. Mumbai +91 22 61713888</p>
<p>ไทย</p>	<p>SMA Solar (Thailand) Co., Ltd. บริษัท สแม โซลาร์ (ไทยแลนด์) จำกัด +66 2 670 6999</p>	<p>대한민국</p>	<p>SMA Technology Korea Co., Ltd. 서울 +82-2-520-2666</p>
<p>South Africa</p>	<p>SMA Solar Technology South Africa Pty Ltd. Cape Town 08600SUNNY (08600 78669) International: +27 (0)21 826 0600 SMA Online Service Center: www.SMA-Service.com</p>	<p>Argentina Brasil Chile Perú</p>	<p>SMA South America SPA Santiago de Chile +562 2820 2101</p>
<p>Australia</p>	<p>SMA Australia Pty Ltd. Sydney Toll free for Australia: 1800 SMA AUS (1800 762 287) International: +61 2 9491 4200</p>	<p>Other countries</p>	<p>International SMA Service Line Niestetal 00800 SMA SERVICE (+800 762 7378423)</p>

## 16 EU Declaration of Conformity

within the scope of the EU directives

- Electromagnetic compatibility 2014/30/EU (L 96/79-106, March 29, 2014) (EMC)
- Low Voltage Directive 2014/35/EU (L 96/357-374, March 29, 2014) (LVD)
- Radio and telecommunications terminal equipment (R&TTE) 1999/05/EC



SMA Solar Technology AG confirms herewith that the inverters described in this document are in compliance with the fundamental requirements and other relevant provisions of the above-mentioned directives. The entire EU Declaration of Conformity can be found at [www.SMA-Solar.com](http://www.SMA-Solar.com).



