

USER MANUAL

DC converter
Standard Model:
LSP 100K Hybrid



“
Where sun shined
Power always on
”



Monitor APP Download



Android



IOS

CONTENTS

1	About This Manual	01			
2	Safety	01			
2.1	Symbol Explanation	01			
2.2	Safety Instruction	02			
3	Brief Introduction	04			
3.1	System Solution	04			
3.2	Working Principle	04			
3.3	Converter Appearance	05			
3.4	Size and Weight	06			
3.5	Storage	06			
4	Unboxing	07			
4.1	Unboxing Inspection	07			
4.2	Recognition Converter	07			
5	Installation	08			
5.1	Basic Installation Requirement	08			
5.2	Select Location	09			
5.3	Size of Wall Mounting Bracket	10			
5.3.1	Transport By Lifting	10			
5.3.2	Transport By Manual Labor	11			
5.4	Install the Converter	11			
6	Connection	13			
6.1	Safety Caution	13			
6.2	Terminal Introduction	13			
6.3	Overview of Wiring	14			
6.4	Protective Earth Connection	14			
6.5	PV out Connection	16			
6.6	PV Connection	18			
6.7	Battery power line Connection	19			
6.8	Battery Communication Cable Connection	20			
6.9	Meter Connection Reserved	21			
6.10	Parallel Communication Connection Reserved	21			
6.11	Wireless Communication Module Connection	22			
7	Operation Guide	23			
7.1	Inspection Before Trial Run	23			
7.2	Working Mode Introduction	23			
7.2.1	Standby Mode	23			
7.2.2	Default Operating Mode	23			
7.2.3	Fault Mode	23			
7.2.4	Programming Mode	24			
7.2.5	Turn off Mode	24			
7.3	Trial Run Steps	24			
7.4	LCD Menu Structure Overview	24			
7.4.1	Home Page	25			
7.4.2	Operation Information	26			
7.4.3	Fault Record	27			
7.4.4	Settings Guidance	27			
7.5	Monitor System	30			
8	Start-up and shut down the Converter	31			
8.1	Start up the Converter	31			
8.2	Shot down the Converter	31			

9	Troubleshooting & Maintenance	32
9.1	Troubleshooting	34
9.1.1	Introduction to LED Displays	34
9.2	Maintenance	34
9.2.1	Regular Maintenance And Recommended Maintenance Cycle	35
9.2.1	Fan Maintenance	35
10	Product Specification	38
11	Appendix	39
11.1	Quality Warranty	39
11.2	Contact Information	39

1. About This Manual

This manual will provide detailed product information and installation instructions for users who use the LSP series of photovoltaic energy storage converters (hereinafter referred to as converter) of Shenzhen Lux power Technology Co., Ltd. (hereinafter referred to as LUX). Please read this manual carefully before using this product, and keep it in a place where it is easy to obtain.





The content of the manual will be continuously updated and revised, but it is inevitable that there will be slight discrepancies or errors with the actual product. Users should refer to the actual product purchased, and download the latest version of the manual through www.luxpowertek.com or through sales channels.

2. Safety

2.1 Symbol Explanation





Symbols in This Manual

The general information and safety instruction is highlighted with following symbols in this manual:

 DANGER	 WARNING	 CAUTION	 NOTICE
“Danger” indicates a hazardous situation which, if not avoided, will result in death or serious injury.	“Warning” indicates a hazardous situation which, if not avoided, could result in death or serious injury.	“Caution” indicates a hazardous situation which, if not avoided, could result in minor or moderate injury.	“Notice” provides tips that are valuable for the optimal operation of your products.

Symbols on Inverter Label

Following list shows the meaning of all the safety symbols on inverter type label:

			
Beware of hot surface. The converter can be hot during operating, avoid contact during operating.	Danger of high voltage. Danger to life due to the high voltages in the converter	Risk of electric shock.	Observe enclosed documentation.
		Danger of high voltage. Residual voltage in the Converter need 5min to discharge, wait 5min before operation.	

2.2 Safety Instruction

General Safety Instructions

The converter has been designed and tested strictly according to international safety regulations. Read all safety instructions carefully prior to any work and observe them at all times when working on or with the converter. The operator must be qualified personnel and the installation must be capable with relevant national or international standards or regulations.

Incorrect operation or work may cause:

- injury or death to the operator or a third party; or
- damage to the inverter and other properties belonging to the operator or a third party.

Important Safety Notifications

There are many safety issues need to be carefully notified before, during and after the installation, and also in future operation and maintenance, following is important safety notifications to operator, owner and user of this product in appropriate usage.

DANGER Dangers of High Voltages and Large Current

- Beware of high PV voltage. Please turn-off the DC switch of PV Panel output before and during the installation to avoid electric shock.
- Beware of large current of the battery output. Please turn-off the battery module before and during the installation to avoid electric shock.
- Do not open the converter when it's working to avoid electric shock and damages from live voltage and current from the system.
- Do not operate the converter when it's working, only the LCD and buttons can be touched in limited cases by qualified personnel, other parts of the converter can be touched when the converter is under a safe state(e.g. fully shut-down).
- Do not connect or disconnect any connections (PV, battery, grid, communication etc.) of the converter when it's working.
- Make sure the converter is well grounding, an operator should make sure itself is good protected by reasonable and professional insulation measurements (e.g. personal protective equipment (PPE)).
- Inspect relevant existed wiring on-site of the installation is under good condition before installation, operation or maintenance.
- Inspect the connections are good between converter and PV, battery and grid during installation to prevent damages or injuries caused by bad connections.

WARNING Avoid misoperation and Inappropriate Usage

- All the work of this product (system design, installation, operation, setting and configuration, maintenance etc. must be carried out by qualified personnel as required.
- All connections must be in accordance with local and national regulations and standards.
- All the warning table or nameplate on the converter must be clearly visible and must not be removed, covered or pasted.
- The installation should choose a right position and location as required in this manual with consideration to safety of users' in future operation.
- Please keep the children away from touching or misoperation the converter and relevant system.
- Beware of burning hurt, the converter and some parts of the system could be hot when working, please do not touch the inverter surface or most of the parts when they are working. During converter working states, only the LCD and buttons could be touched.

CAUTION

- Only qualified personnel can change the converter settings.
- There might be possible damage to health as a result of the effects of radiation, do not stay closer than 20cm to the converter for long time.

NOTICE

- Please carefully read this manual before any work carried out on this converter, after the installation, please keep this manual carefully stored and easy to access at any time.
- The qualified personnel should have had training in the installation and commissioning of the electrical system as well as dealing with hazards, also they should have the knowledge of the manual and other related documents. As the installer or operator they are required to be familiar with local regulations and directives.

3. Brief Introduction

3.1 System Solution

LSP100K is a PV energy storage converter, which is an important part of the photovoltaic energy storage station. This product and relevant system is suitable for following system applications (system diagram):

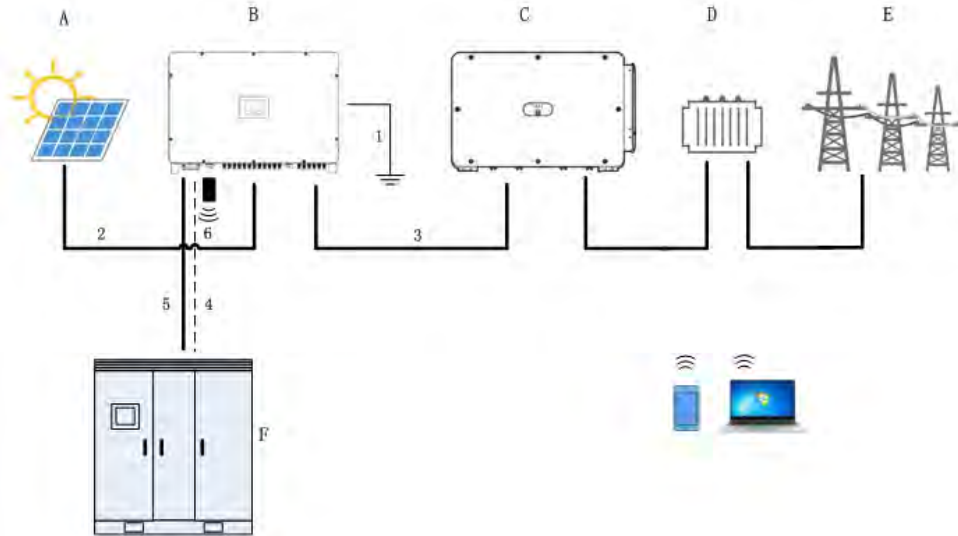

Name	Description	Remark
A	PV String Array	Mono silicon, poly silicon, thin film battery without grounded
B	PV Energy Storage Converter	LSP100K
C	Grid-tied Solar Inverter	Such as SG100CX SUN2000 etc.
D	Grid Transformer	Converting the output voltage of the inverter to meet the requirements of the grid
E	Grid	Grid supported by inverter
F	Battery	Zerata Battery etc.

3.2 Working principle

The working principle of LSP100K is as follows:

1. DC current generated by PV string array will be input to the LSP100K
2. The LSP100K converter will store the excess DC Power in the battery, or withdraw energy from the battery and input to the PV output port according to the instruction.
3. The PV out port of LSP100K input the energy from the PV string or the battery energy or the sum of the two parts to the photovoltaic inverter by simulating the curve of the solar cell.
4. The PV inverter converts the DC power to AC power.
5. Output voltage of the AC power is transformed by the transformer to meet the requirements of the grid.

3.3 Converter Appearance

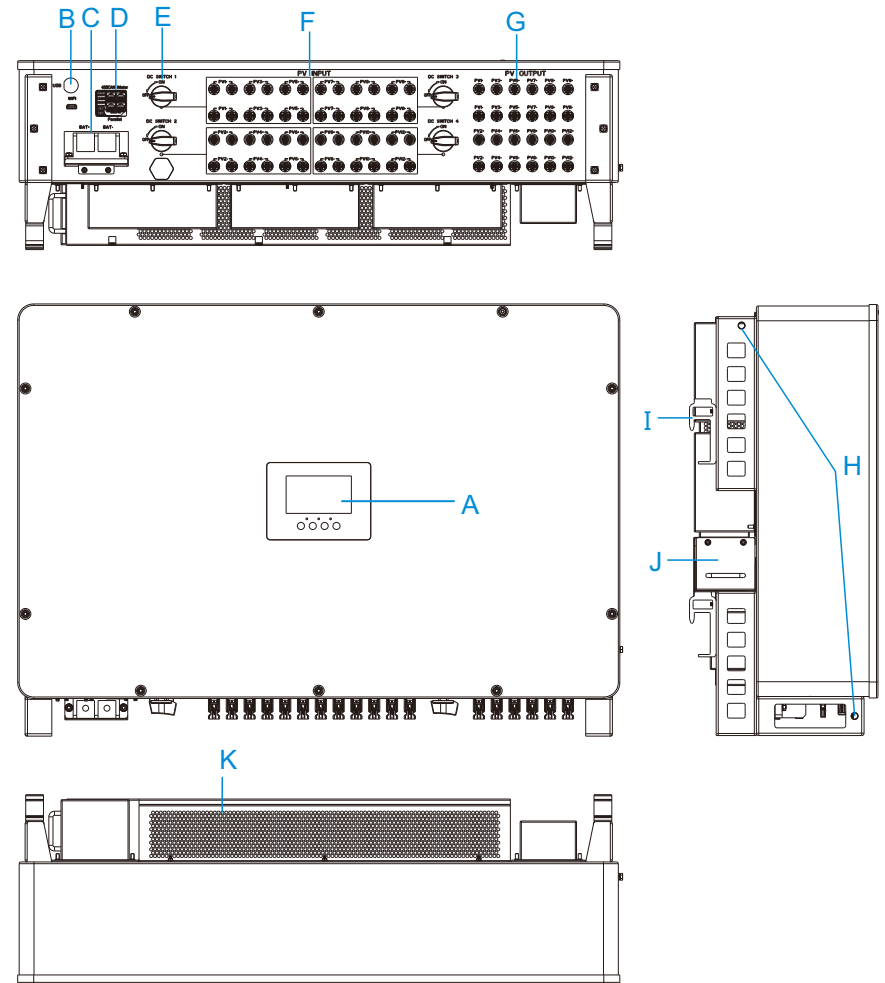

Name	Description	Name	Description
A	LCD	G	PV Output Wiring Area
B	Communication Module Port	H	Outlet Of Cooling Air
C	Battery Wiring Terminal	I	Hanging Loop
D	Others Communication Port	J	Fan Bracket
E	PV SWITCH	K	Lifted Ring And Screw Holes Of Installation Handgrip
F	PV Input Wiring Area		

3.4 Size And Weight

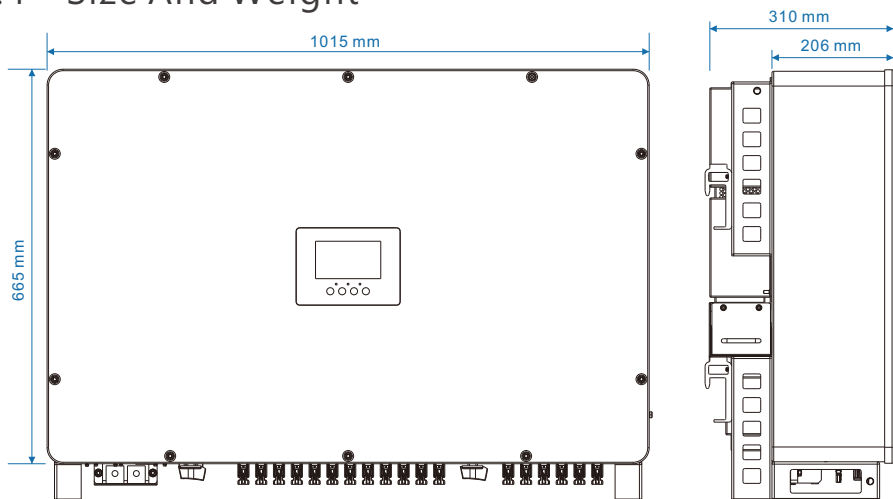

Model:	Size (L*W*H)	Weight:
LSP100K	1015*(665+64)*310mm	120KG

3.5 Storage

1. The converter is best stored in the original packaging bag and placed in a ventilated and dry place
2. The storage temperature range is: -25°C~60°C, and the storage humidity is 0~95%.
3. If there are many converters that need to be stacked for storage, the number of layers stored with packaging cannot exceed the "stacking layer limit" marked on the outer box.
4. The packing box cannot be tilted or turned upside down



4. Unboxing

4.1 Unboxing Inspection

1. Before opening the inverter package, please check whether the outer package is damaged.
2. After unboxing, please check whether the converter is damaged or lack of accessories. If there is damage or lack of accessories, please contact the manufacturer

Converter X1	User Manual X1	Communication Port Cover X1	Battery Cover X1	PV Terminal X72
Wall-mounted Bracket X1	Rj45 Terminal X4	Cross Head Screw X13	PV Connector X72(+/-)	Waterproof plug X36(-)
				
Expansion Screw and Tube X8	Metal rings X4	4G Module X1	Waterproof plug X36(+)	

4.2 Recognition Converter

The nameplate is pasted on the side of the converter. The nameplate provides the model information of the converter and the most important parameters and certification marks, etc.

Refer to the given picture

DC/DC Converter	
Model	LSP-100K Converter
Max. input power	200kW
Max. input voltage	1100V
Input nominal voltage	630V
Input voltage range	300-1000V
Start voltage	330V
Max. short current per MPPT	40A
Max. current pre MPPT input	26A
Number of MPPT tracks	12
Number of input strings	24
Output rated power	100kW
Normal output voltage	630V
Output voltage range	500-1000V
Max output current	20A
Output strings	12
Output tracks	12
Battery type	Lead-acid/Lithium
MAX. charge and discharge power	100kW
Voltage range	300-700V
Max. charge and discharge current	200A
Max. charge and discharge efficiency	98.5%
Operating ambient temperature range	-25-60 °C
Ingress protection	IP65(Outdoor use)
Protective class	I
Over voltage category	III

Please reconfirm whether the inverter model and specifications meet the requirements.

5. Installation

5.1 Basic Installation Requirement

1. The wall where the converter is installed must be sturdy and able to bear the weight of the converter for a long time (for weight data, please refer to section 3.4)
2. The installation site needs to meet the size of the converter. When installing on a wall, it needs to avoid the water and electricity wiring in the wall.
3. Do not install the converter on a building made of flammable or heat-resistant materials.
4. The protection level of the machine is IP65, and it can be installed indoors and outdoors. Please refer to the chapter for specific installation requirements.
5. The environment temperature for installing the converter should be between -25°C ~ 60°C , and the humidity should be between 0~95%.
6. The installation location should be convenient for electrical connection, operation and maintenance.
7. It is very important to ensure smooth ventilation and heat dissipation of the converter. Please install the converter in a ventilated environment.
8. The converter should be installed at a location greater than 30m away from third-party wireless communication facilities and living environment and away from strong electromagnetic signals.
9. The converter can be installed on a vertical or backward inclined plane or placed flat on a bracket at least 1m above the ground, please refer to the following figure:

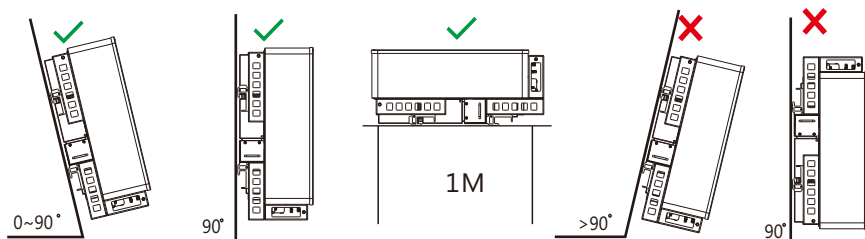

10. In order to ensure the normal operation of the machine and the convenience of personnel operation, please pay attention to provide enough clearance for the converter, please refer to the following figure:

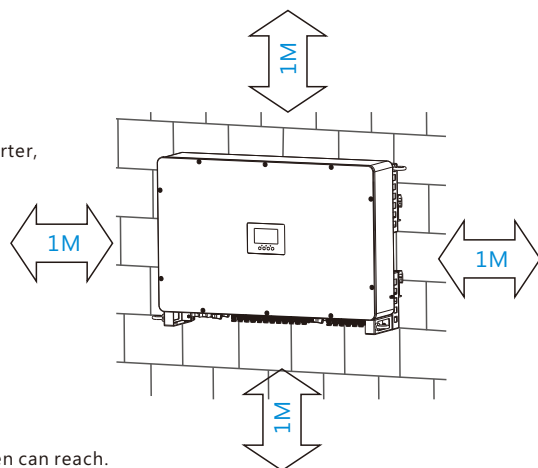

11. Do not install the converter where children can reach.

5.2 Select Location

The LSP100K are designed as IP65 devices with a capability to be installed in both outdoor and indoor conditions. However, selecting an optimal installation location is highly recommended to increase the safety, performance and lifespan of the Converter.

Suggestions and Requirements

1. Although the converter is IP65 rated, it can extend the service life of the machine by avoiding the converter from being exposed to rain and snow, as shown in the figure below:

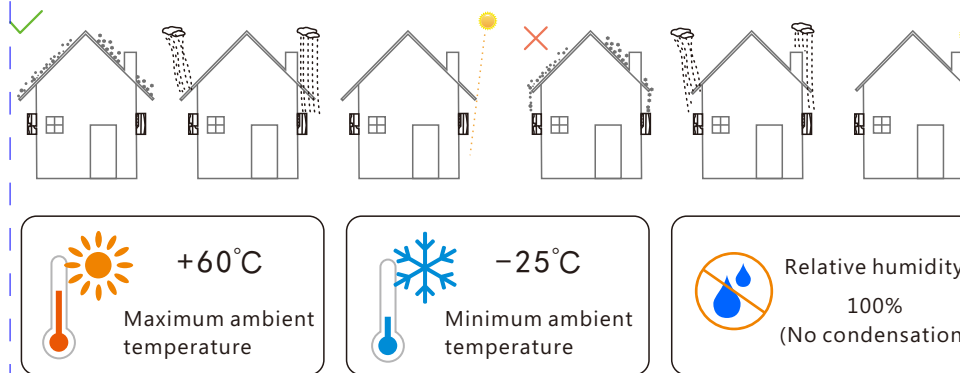

2. Install multiple converters on the same plane, and the installation distance parameters between the converters are shown in below:

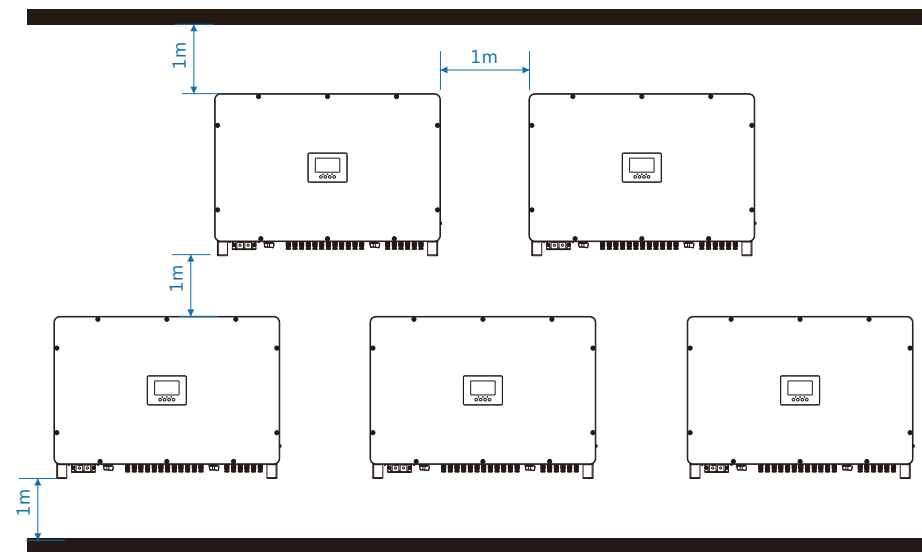

- Do not install the converter in a closed and small space, as shown in the picture below:

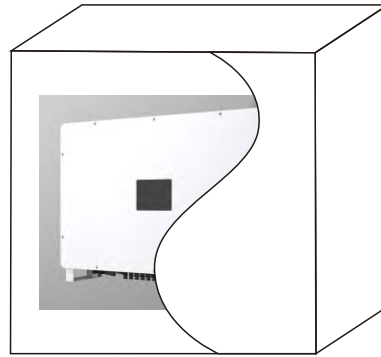

5.3 Transportation

The converter needs to be transported to the selected installation site before installation. When transporting the converter, you can choose to transport it manually or by lifting according to the site conditions.

5.3.1 Transport By Lifting

- As shown in the picture below, lock the lifting rings in the four positions of the converter, and then use the rope to pass through the four lifting rings and fasten the binding.
- Use lifting equipment to lift the converter 100mm off the ground and then pause, check the tightness of the lifting ring and rope. After confirming that the connection is secure, lift the converter smoothly to the destination.

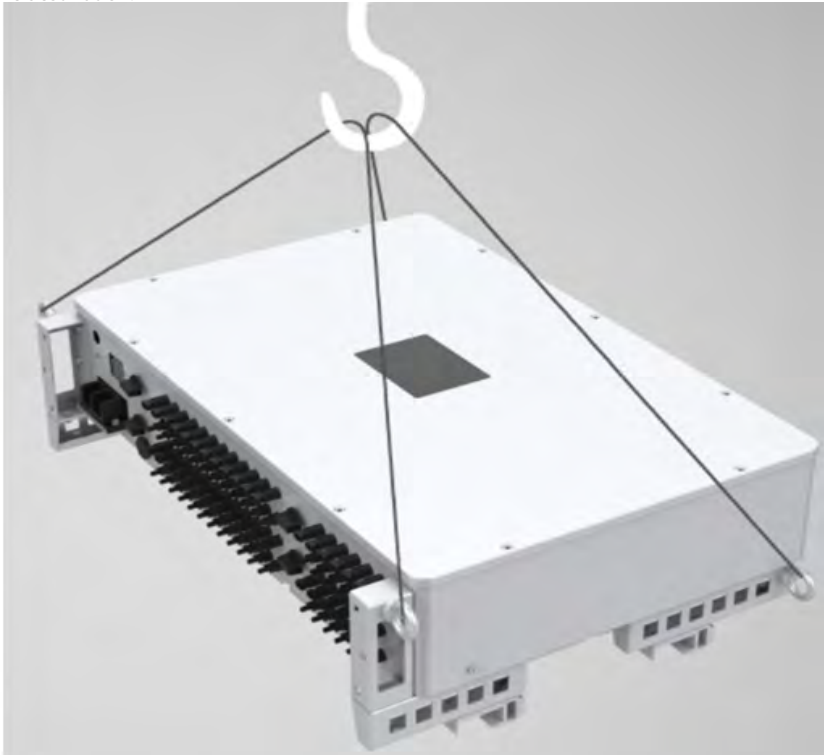

5.3.2 Transport By Manual Labor

- As shown in the picture below, 4~6 people respectively extend their hands into the package, lift the converter out of the package, and then retract the carrying handle (optional) into the hole to manually lift the converter to the installation position.
- When transporting the converter, please keep the balance of the converter.

Notice

- The front and bottom are marked on the packing box.
- During manual transport, the machine is heavier, so you need to pay attention and check if the human force can bear the weight.



5.4 Install the Converter

The Converter is wall-mounted installed , steps shows below

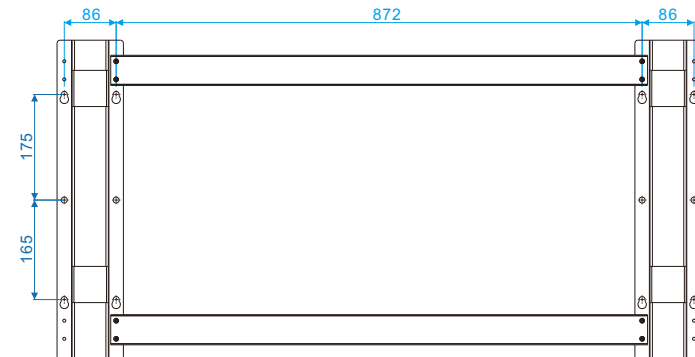

The inverter is wall-mounted installed, steps shows below:

Step1. Install the wall mount bracket. Use the wall mount bracket as a template, drill holes on the wall according to the position of the screw holes on the wall mount bracket, and insert expansion bolts.

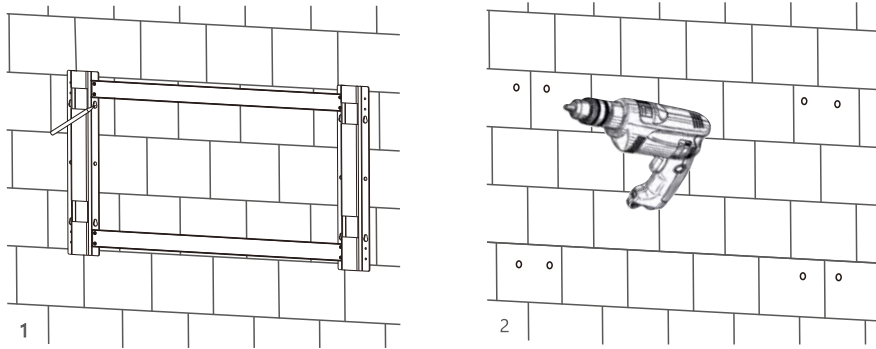

Step2. Fix the wall mount bracket to the wall with screws.

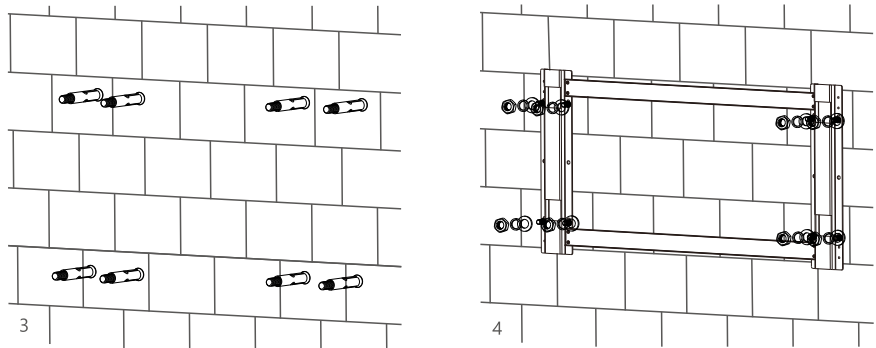

Step3. Use the hoisting rope (need to meet the load-bearing requirements of this product), go through the top hoisting hole of the converter, and lift the machine and place it on the wall mount bracket.

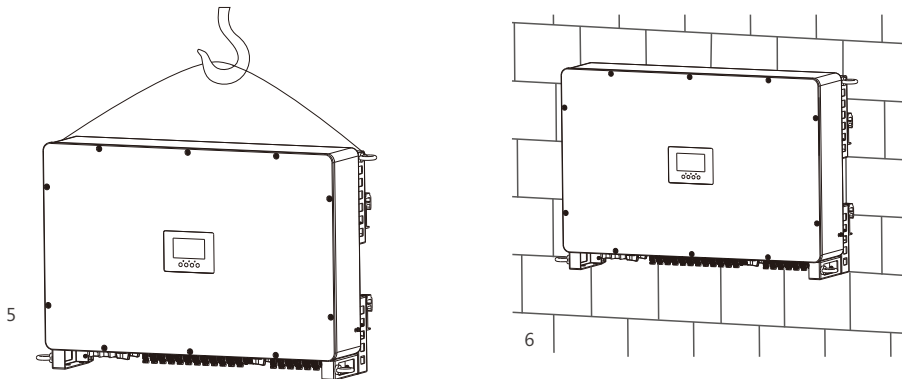

6. Connection

6.1 Safety Caution

During electrical operation, professionals must wear protective equipment.

- ⚠ DANGER**
1. There may be high voltage in the converter!
 2. The PV strings will generate dangerous voltage while exposing to the sunlight.
 3. Do not close the circuit breaker before completing the electrical connection.
 4. Before making electrical connections, make sure that all cables are not live.

- ⚠ WARNING**
1. Any improper operation during the wiring process may cause equipment damage or personal injury or death.
 2. The wiring operation must and only allow professional and technical personnel to complete.
 3. The cables used in the photovoltaic power generation system must be firmly connected, intact, well insulated and of appropriate specifications.

- NOTICE**
1. The wiring process must follow the relevant safety instructions of the PV string.
 2. All electrical installations must comply with the electrical standards of the country/region where the installation is located.

6.2 Terminal Introduction

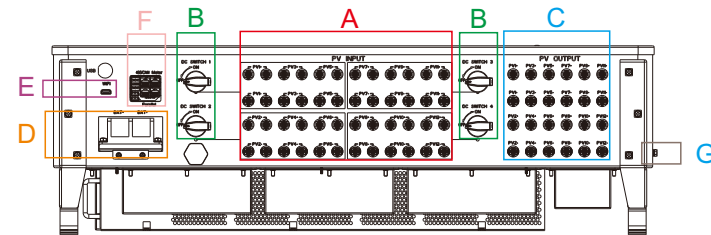

Code	Name	Silk Screen	Remark
A	PV String Input Terminal	PV INPUT	MC4 PV Connector LSP100K is equipped with 24 pairs of terminals
B	PV switch	DC SWITCH	PV switch,used to switch on/off of PV input
C	DC Output Terminal	PV OUTPUT	MC4 PV Connector LSP100K is equipped with 12 pairs of terminals
D	Battery Terminal	BAT+ /BAT-	For battery wiring
E	Communication Terminal	WIFI	For RS485, CAN communication and other wiring use.
F	Monitoring Port	485CAN/METER/ PARALLEL	For RS485, CAN communication and other wiring use.
G	Secondary Ground Terminal		It is used for reliable grounding of the converter

6.3 Overview Of Wiring

The connection of the converter to the PV energy storage system includes: secondary ground connection, PV string connection, battery connection and PV inverter connection.

The system wiring diagram is as follows:

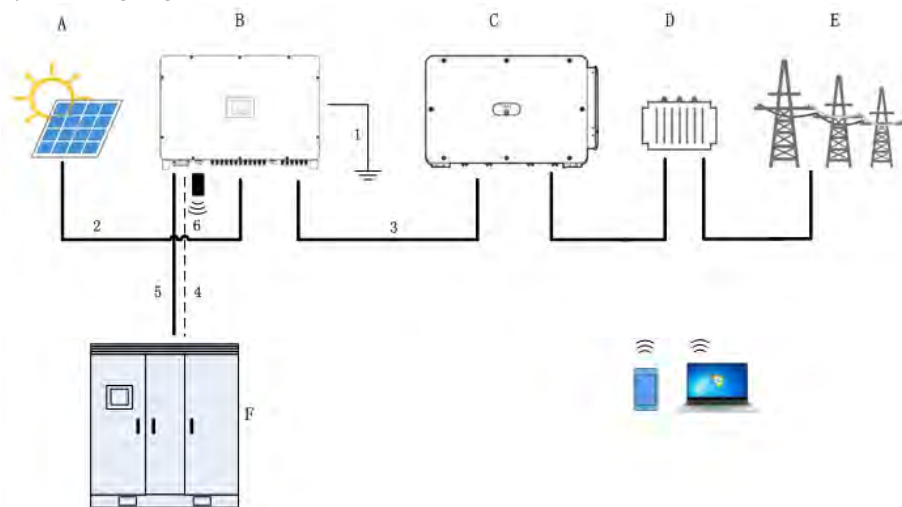

According to the actual application scenario, please prepare the corresponding cable by yourself

Code	Electrical Name	Type	Conductor Cross-sectional Area
1	Protective Ground Cable	Single multi-core yellow-green wire	Copper wire (35~50mm ²)
2	PV Input Cable	Single multi-core copper wire	Copper wire (4~6mm ²)
3	PV Output Cable	Single multi-core copper wire	Copper wire (4~6mm ²)
4	Battery Power Connection Cable	Single multi-core copper wire	Copper wire (60-95mm ²)
5	Battery Communication Cable	CAT-5 Ethernet cable (RJ45) Outdoor shielded twisted pair	
6	Wireless Monitoring	WiFi/GPRS/4G	No cables required

6.4 Protective Earth Connection

⚠ WARNING

- If the PV inverter in the system is transformerless and the system is connected to the grid without an isolation transformer, the positive and negative poles of the PV string must not be grounded, otherwise the system will not operate normally.
- Before connecting the PV string, PV inverter, battery and communication, please make a protective ground connection.
- In the PV power generation system, all non-current-carrying metal parts and equipment enclosures need to be grounded.
- The PE cables of the converter and the PV inverter and the metal frame of the PV array need to be connected to the same ground to achieve equipotential connection.

● NOTICE

Take care to prevent rain at the grounding wire terminal joint, and do not expose it to the air directly. When locking the housing ground screw, the torque is 60kgf.cm.

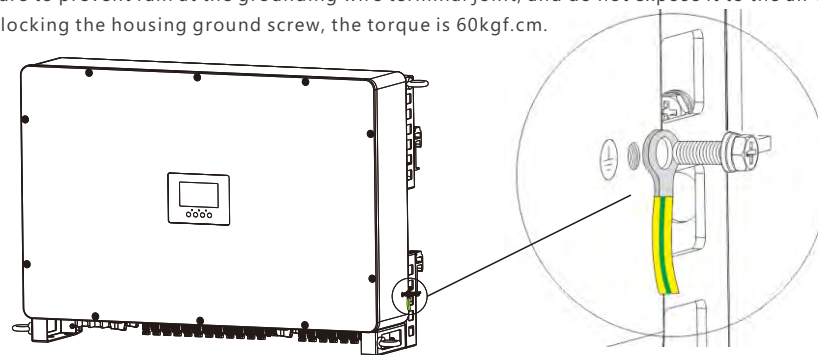

According to the relevant provisions of IEC61643-32, it is necessary to ensure the implementation of lightning protection measure for PV systems

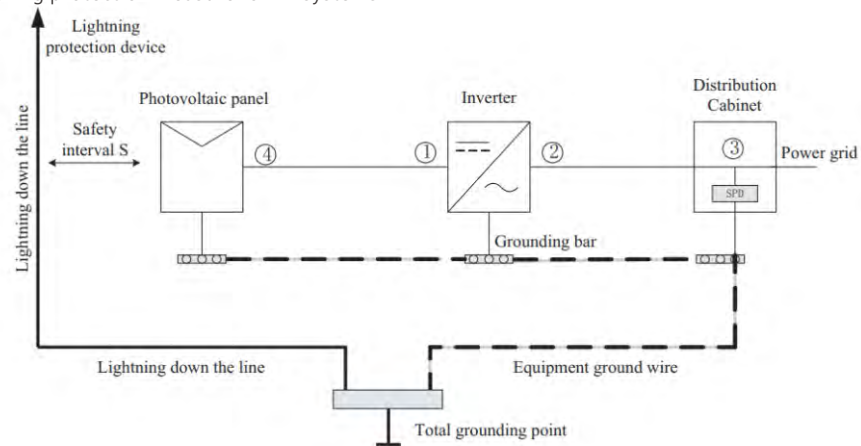

- 1. Generally, it is recommended to install lightning protection devices (such as lightning rods/lightning strips and down conductors) to prevent lightning from directly hitting the PV array.
- 2. Lightning protection devices and down conductors should maintain a safe distance from the related equipment in the photovoltaic system (including PV strings, converters, inverters, cables, and power distribution equipment).

2.1 The recommended value of S: According to the roof of a general 5-story building (approximately 15m), 2.5m is sufficient for S. This distance can be simplified and calculated according to the inverse relationship between the height of the floor.

2.1.1 When the safety distance S is met:

As shown in the picture, positions 1 and 3 should be equipped with lightning protection modules. Normally, it is recommended that position 1 pretend to be type II, and position 3 pretend to be TYPE1;

2.1.2 When the safety distance S is not met:

In addition to position 3, type I lightning protection modules should be installed in picture 1, 2, and 4;

- 3. The lightning down conductor and the equipment grounding wire eventually converge at a general grounding point, but the two cannot share wires. That is, the equipment grounding wire should be pulled separately, and the wire diameter requirement is $> 6\text{mm}^2$ under the condition of meeting the safety spacing distance S;

WARNING

Lightning protection measures for PV systems should be implemented in accordance with the corresponding national standards and IEC standards, otherwise it may cause cumulative damage to PV devices such as components, converters, inverters, and power distribution facilities. In this case, the company does not carry out quality assurance and assumes any responsibility.

6.5 PV out Connection

Cable Requirement:

Cross-section	Cable Diameter	Max Voltage
4-6 mm ²	2.5-4 mm	1000 V

NOTICE

1. Please use the connecting terminals provided with the converter and other types of terminals may cause poor contact and cause fire.
2. Before wiring, please make sure that the converter is off and there is no residual voltage at the PV output port
3. Before wiring, please make sure that the PV inverter is in the shutdown state and the PV switch of the PV inverter is also in the off state.
4. Please do not connect all PVout output wires together and then connect to the inverter.

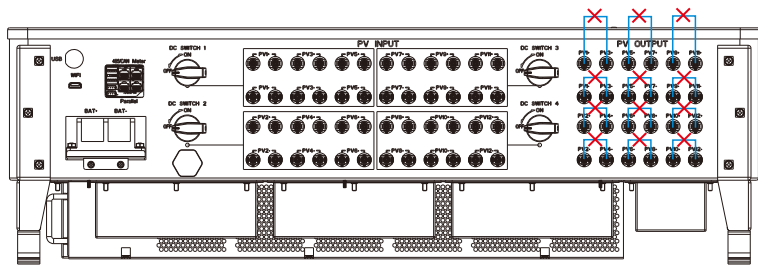

5. Please put a waterproof rubber plug on the unconnected PVout terminal

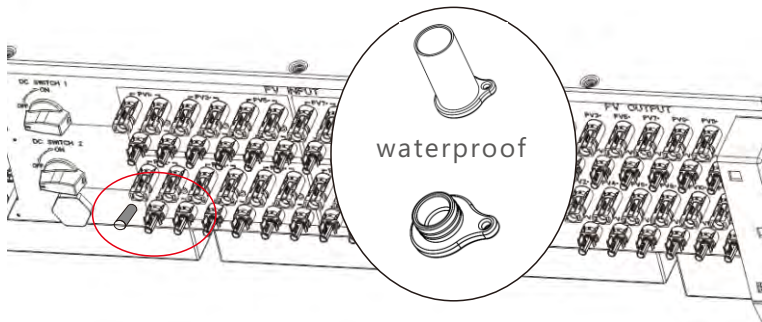

The wiring steps are as follows:

1. Strip the cable insulation layer and cover the cold-pressed terminal

4. Tighten the sealing nut

2. Use crimping pliers to crimp the terminal to ensure that the cable cannot be pulled out after crimping

5. Confirm that there is no voltage at the output port of the converter

3. Assemble the cables into the positive and negative connection terminal shells to ensure a firm connection

6. Insert one end of the converter into the PV terminal corresponding to the PV output wiring area of the converter

DCDC Converter

Inverter

6.6 PV Connection

The PV connection of LSP100K is the same to traditional on-grid solar inverter (string inverter).

● NOTICE

- Before connection the PV, please use the multi-meter to measure the PV array voltage to verify if PV array is working normally, if not, please fix the PV array to normally working states before connection.
- When your PV panel ambient temperature could possibly be lower than 0℃, then please check the PV array voltage up ceiling and if you are not sure please ask your system or panel provider for further assistance. As when temperature is extremely low the PV panel voltage will increase by a certain percentage.
- Turn off or disconnect the PV switch (DC switch). Then keep this switch always open during the connection.
- Please connect the PV panels of each string to the LSP100K machine separately. It is strictly forbidden to connect all the PV strings together and then connect them to each input of the LSP100K separately.
- Each MPPT tracker of LSP100K can connect two PV strings.

Cable Requirement:

Cross-section	Cable Diameter	Minimum Voltage
4 - 6 mm ²	2.5-4mm	1000V

1. Strip the cable insulation layer and cover the cold-pressed terminal 8-10mm



2. Use crimping pliers to crimp the terminal to ensure that the cable cannot be pulled out after crimping

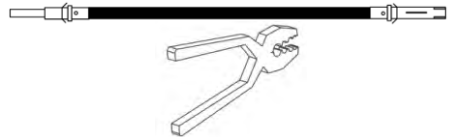

3. Assemble the cables into the positive and negative connection terminal shells to ensure a firm connection



4. Tighten the sealing nut

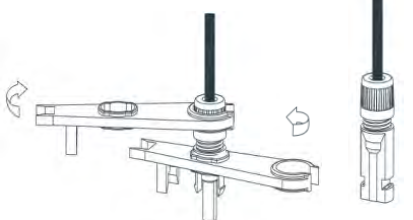

5. Check the polarity of the PV string cables and ensure that the highest voltage does not exceed 1000V

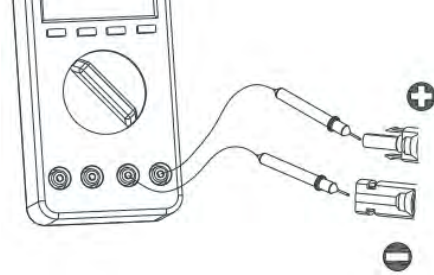

6. Confirm that all DC switches are in the "OFF" state, and then insert the PV connector into the PV terminal corresponding to the PV input wiring area of the converter

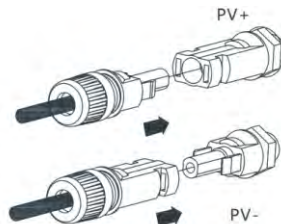

6.7 Battery power line Connection

This part in this manual only describe the battery connection on Converter side, should you need more detailed information regarding the battery connection on battery side please refer to the manual of the battery.

● NOTICE

- Make sure that the converter is powered off and there is no residual voltage at the battery interface. If the battery side line is connected, make sure that the battery is off.
- When the battery is charging and discharging, the current is big, please be sure to tighten the connection screws.
- Note that if there is a switch connected between the converter and the battery, make sure that the switch is in the off state.
- Please note that there is a large current from the battery to the converter, so it is recommended that the installation distance is not too far.

Cable Requirement:

Cross-section	70 - 90 mm ²
---------------	-------------------------

1. Unscrew the terminal head of the waterproof cover and pass the battery cable through the waterproof head and waterproof cover

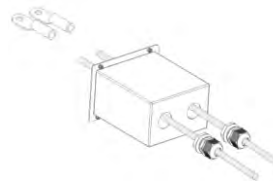

2. Strip the insulation of the cable, install heat shrink tubing and OT/DT terminal



3. Press the DT terminal sleeve wire barrel with hydraulic pliers to ensure that the wire and the terminal are firmly connected

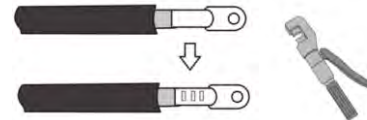

4. Use a heat gun to fix the heat shrink tube



5. Fix the cables to the corresponding terminals according to the positive and negative polarities of the battery side (be sure to connect according to the correct polarity, reverse connection will cause damage to the converter and battery)

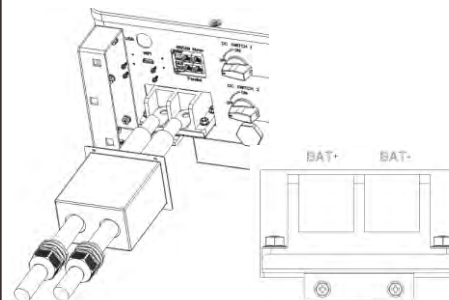

6. Tighten the sealing nut of the waterproof head

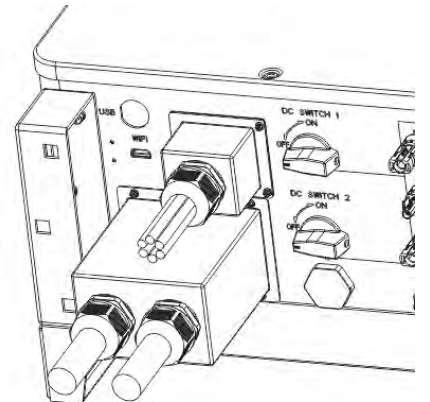

6.8 Battery Communication Cable Connection

NOTICE

The battery usually comes with a network cable, please use the battery's own network cable for connection first

If you need to replace the network cable, please choose a 568B type of CAT5 or above network cable.

1. Unscrew the terminal head of the waterproof cover of the communication cable and pass the battery communication cable through the waterproof head and the waterproof cover

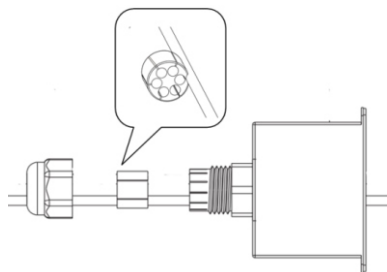

2. Pin 3 is connected to CAN L, and pin 4 is connected to CANH (Note: this line sequence is the line sequence of the converter side, please refer to the battery specification for the line sequence of the battery side)

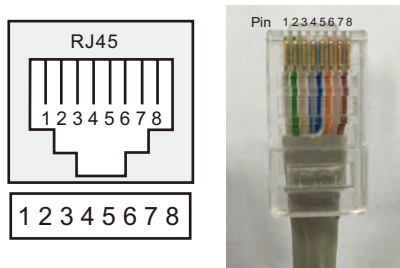

3. Insert the crystal head into the corresponding connection port of the converter

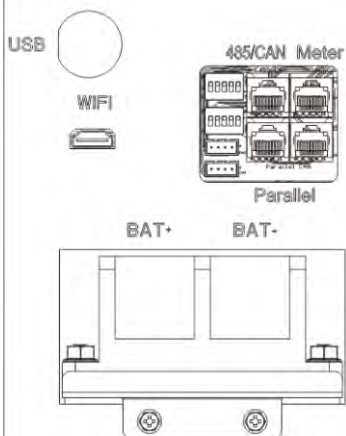

4. Install the waterproof cover and tighten the waterproof nut

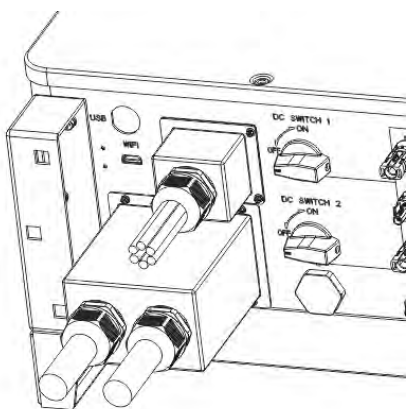

6.9 Meter Connection Reserved

NOTICE

- The LSP100K reserves the meter access port, which can be connected to the LSP100K through RS485, so that the LSP100k can obtain the power information on the grid side.
- If you need to obtain grid-side information through LSP100K monitoring, please contact LUX to obtain electricity meters and update machine program information.
- For meter connection, please use a straight-through network cable above CAT5 to connect to the converter.

The communication port for communicate with meter or CT clamp is as below:

Rj45 Terminal Configuration of Meter/CT Communication

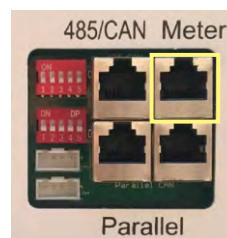

Pin	Function Description
1	METER 485 B
2	METER 485 A
3/4	NC
5/6	Reserved
7	CTN
8	CTP

6.10 Parallel Communication Connection Reserved

NOTICE

- The LSP100K reserves the solar radiation tester access port, which can be connected to the LSP100K through RS485, so that the LSP100k can obtain the sunlight intensity information.
- If you need to obtain solar radiation information through LSP100K, please contact LUX to obtain the recommended radiation tester and update the machine program information.
- To connect the radiation tester, please use a straight-through network cable above CAT5 to connect to the converter.

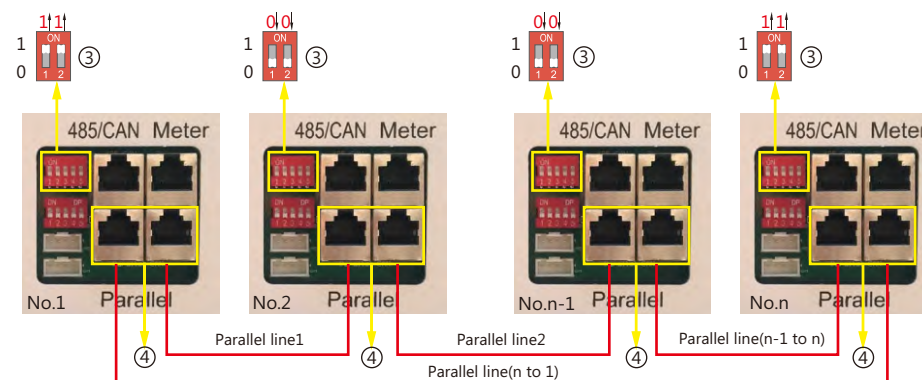

The max parallel quantity is 10, so $2 \leq n \leq 10$

6.11 Wireless Communication Module Connection

NOTICE

- The LSP100K reserves the parallel communication access port, which can be connected to the LSP100K through CAN, so that the LSP100k can obtain the information of the parallel information (such as multiple equipment using the same battery, etc.).
- For parallel communication connection, please use a straight-through network cable above CAT5 to connect the converter.
- If you need to use parallel communication, please contact LUX to confirm the information and update the program.

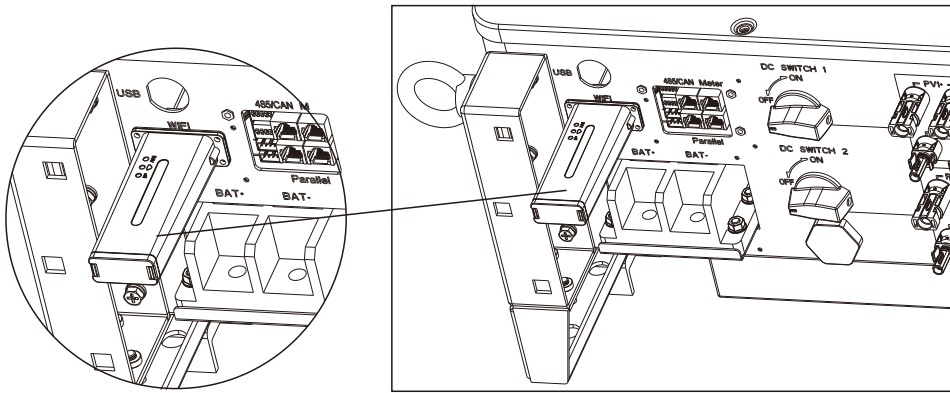

The Wireless Communication Interface Details

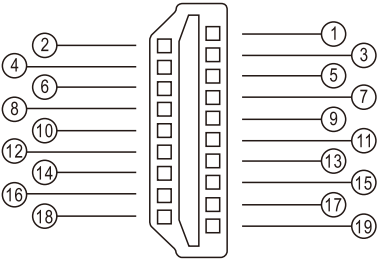

Pin	Function Description
1 & 2	VCC
3 & 4	GND
5	RS485-A
6	RS485-B
Others	Reserved

Currently LSP100K supports the communication of wifi, 4G, GPRS and other wireless modules.

7 Operation Guide

7.1 Inspection Before Trial Run

Code	Inspection Item
1	The converter is installed correctly and firmly
2	Ground wire, PV input wire, PV output wire, battery power wire are all connected correctly and firmly
3	Battery communication cable, WIFI connection is correct
4	The waterproof head and waterproof cover are installed correctly and firmly
5	Cable arrangement is reasonable and protected, no mechanical damage
6	No debris scattered in the installation space, enough space for heat dissipation

7.2 Working Mode Introduction

7.2.1 Standby Mode

In this mode, the machine will not run and is in a waiting state. At this time, the converter will continue to accept instructions or detect system parameters, and when conditions permit or settings are changed, the system will try to enter the working mode state.

7.2.2 Default Operating Mode

The default operating mode of LSP100K is as follows:

1. The PVout output terminal outputs to the photovoltaic inverter according to the default 12 channels of 100kW, and the PVin input terminal performs MPPT tracking on the input photovoltaic string and tracks the maximum photovoltaic power generation energy sent to the battery.
2. When the PV input energy is greater than 100kW (the default output power of PVout), the excess energy will be stored in the battery, and the battery capacity will increase.
3. When the energy input by PV is less than 100kW (the default output power of PVout), the excess energy will be discharged from the battery, and the capacity of the battery will decrease.
4. As in article 2 above, if it continues until the battery is fully charged, the system will automatically reduce the PVin input power to a basic equilibrium state with the PVout output power, and maintain a power output of 100kW.
5. As in article 3 above, if it continues until the battery discharges, the system will automatically reduce the PVout output power to slightly less than the PVin input power to keep the battery from entering a power-deficient shutdown state

7.2.3 fault Mode

Converter's intelligent control system will continuously monitor and adjust the state of the system. When the converter detects any failure, the alarm or failure LED indicator lights up or flashes red, and the corresponding failure information display can be viewed on the LCD.

7.2.4 Programming Mode

Converter updates the program mode. In the initial stage, the machine will download the program into the storage unit of the converter, and then enter the program update state, and the machine will not work in the program update state.

7.2.5 Turn Off Mode

When the battery is turned off and the sunshine is very weak, the converter will automatically stop working, and the converter's display system will also shut down at this time. At this time, the machine will not consume the energy of the PV string and battery.

7.3 Trail Running Step

- 1: Turn on the PV switch of the PV inverter in the system to ensure that the energy at the PVout output end of the LSP100K can enter the PV inverter. As shown in picture 6.3 above, the path "3" is turned on.
- 2: Turn on the PV switch of the LSP100K to ensure that the energy of the PV string can enter the LSP100K. As shown in picture 6.3 above, the path "2" is turned on.
- 3: Finally turn on the battery connected to the LSP100K to ensure that the energy of the battery can enter the LSP100K. As shown in picture 6.3 above, the path "4" is turned on.
- 4: If there is a DC switch between the battery and the LSP100K, be sure to turn on the DC switch first, and then turn on the battery.
- 5: After all is completed, and waiting for a while, the LSP will automatically enter the default working mode described in 7.2. Observe the power flow indication on the LCD and the information indication on each page (see details)

Note: When there is a DC switch between the LSP100K and the lithium battery, make sure to close the DC switch first, and then turn on the battery, because there will be a pre-charge process when th

7.4 LCD Menu Structure Overview

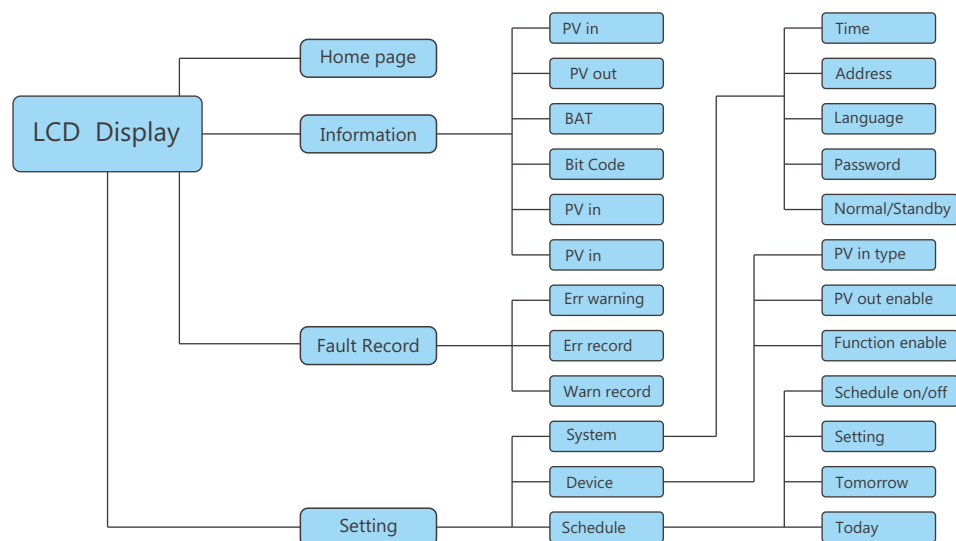

7.4.1 Home Page

The home page is shown below:

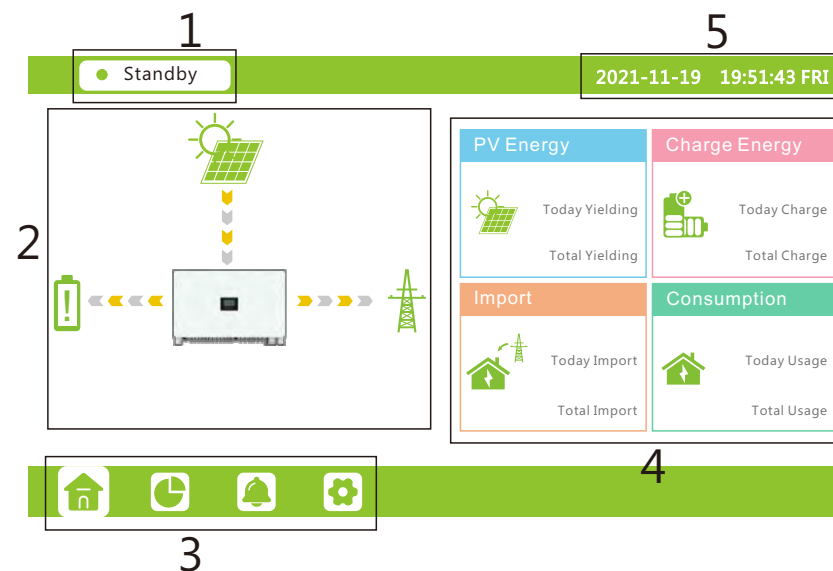

Home page function area description:

Code	Name	Explanation
1	Converter status	Display the current operating status of the converter, see section 7.2 for details.
2	Trend Mapds	Display information such as PV power generation, charging and discharging power, and PV inverter power. The arrow between the icons indicates that there is energy flow between devices, and the direction of the arrow indicates the direction of energy flow.
3	Navigation Column	Contains "Home", "Operation Information", "Fault Records", and "Settings" menus
4	Energy accumulation Column	Display the PV power generation, battery discharge energy, the energy sent to the PV inverter and the total energy consumption?
5	Date And Time	Display the system date and time of the converter.

7.4.2 Operation Information

Click  in the navigation column to enter the operation information page, as shown below:

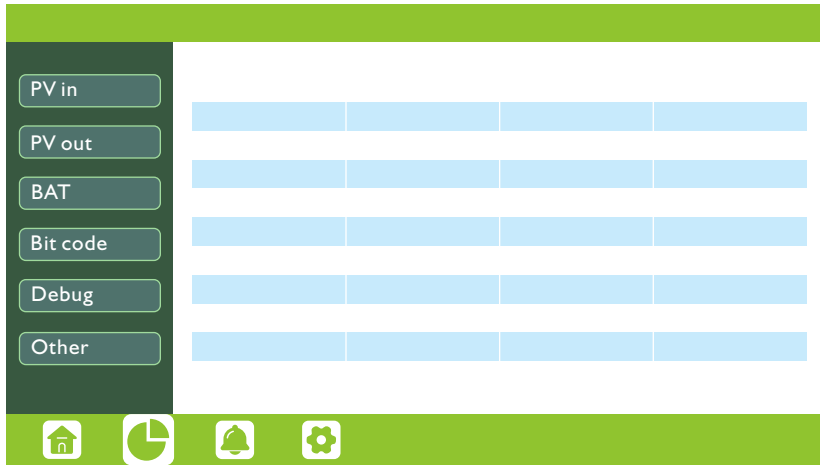

Operation information description:

Category	Parameter Name	Parameter Description
PV Information	String n voltage	The input voltage value of the n-th string
	String n current	Input current value of the n-th string
	String n power	The input power value of the n-th string
PV out Information	Output n voltage	The voltage value of the n-th output
	Output n current	Current value of the n-th output
	Output n power	The power value of the n-th output
Other operating information such as battery	Battery information	Battery SOC, voltage, power, current and buckboost power loop current, bus voltage, BMS upload information data, etc.
	Power device and heat sink temperature	Power module temperature and input and output heat sink temperature
	Fan information	Speed display of each fan
Bit code	Running internal information	Internal operating data information
Debug	Running internal information	Internal operating data information
Others	Machine information	Including the model number, serial number and version of firmware.

7.4.3 Fault Record

Click  in the navigation Column to enter the operation information page, as shown below:

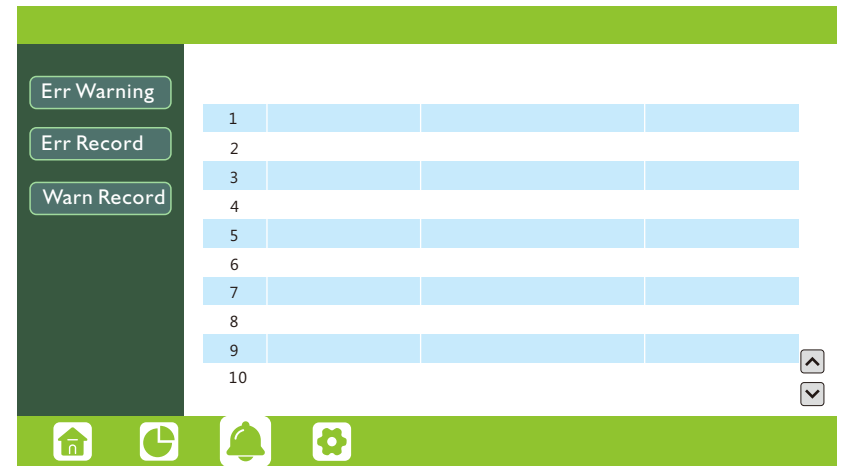

Description of fault record information:

Category	Description
Fault/warning	Real-time display of all warnings and fault messages of the machine.
Fault Record	Display the history record of the fault information, which is convenient to check the past history data, total xxx pieces
Warning Record	Display the historical record of the warning message, which is convenient for checking the past historical record data. Total xxx Piece

7.4.4 Settings Guidance

Click  in the navigation column to enter the operation information page, as shown below:



Parameter setting description:

Category	Description
System setting	User can set the system time, address, language, password, total output power limit and switch on this page
Machine setup	User can set the PVin input mode, PVout output channel switch and the opening of some machine functions on this page
Running sequence setting	User can set the operating output power for the next day and view today's operating output power on this page in units of half an hour.

System setting

In the system setting interface, if you need to enter values, such as time, address, password and output power setting, a number box will pop up, as shown below:

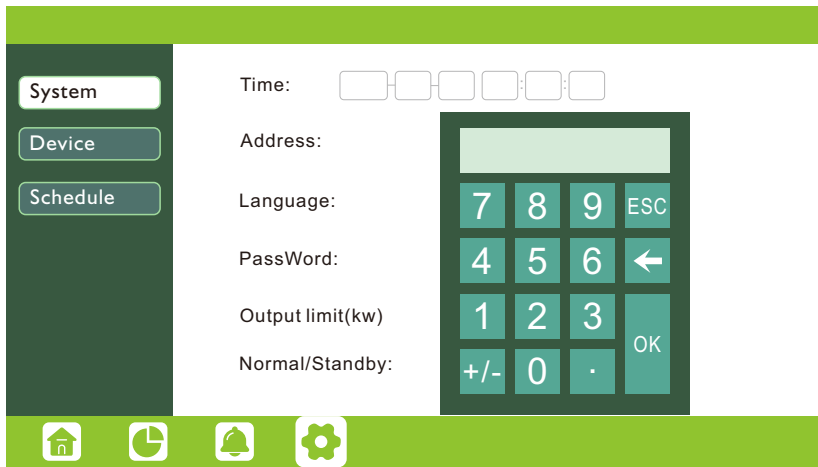

After selecting the corresponding value, click OK, and the number box will be automatically hidden to complete the value input.

Notice:

- Some values have a limited maximum range, for example, date and time have a standard format, and the time is in a 24-hour system. The maximum value of the address is 255, and the password is four digits. The maximum output power limit is 100kW.

In the column that are not numeric input, such as the language column, directly click the "set" button to switch the language. Currently, only English is available, and there are reserved Chinese, German and Japanese options. The Normal/standby key is used to force the machine state to switch. Normal is the normal working state of the machine. When standby is selected, the machine will automatically enter the standby state.

Machine setup

There are three options in the machine setting interface, click on the PVintype option



You can change the PV input tracker mode from 12 independent channels to 2 channels in parallel, that is, PV1, PV2 in parallel, PV3, PV4 in parallel... 6-channel MPPT tracker working mode, in this mode, the user can change The PV strings are connected in parallel in pairs before being inserted into the LSP100K system. As far as the number of PV strings is constant and the installation positions are the same, the number of PV wiring can be reduced.

In the PVoutEn navigation column, click the "set" button to enter the sub-level menu:

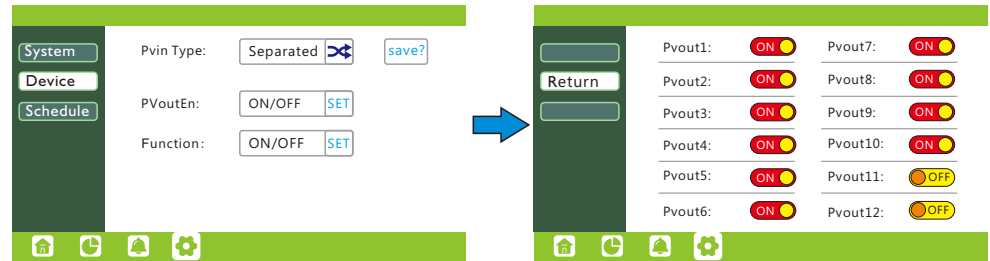

The user can choose to turn off certain channels of output, as above, ON means that the corresponding output is turned on, and OFF means that the corresponding output is turned off.

The converter outputs according to the default value of 100K (the "output limit" in the "system" setting column may be adjusted). Normally, 12 channels output 100k. If PVout11 and PVout12 are turned off, if the current of each channel does not reach the maximum output current, It is still possible to keep the default 100K (or set the adjusted value) output. If each current reaches the maximum value, the output power may be lower than 100K.

Click "return" to return to the previous menu.

In the function navigation column, click the "set" button to enter the sub-level menu:

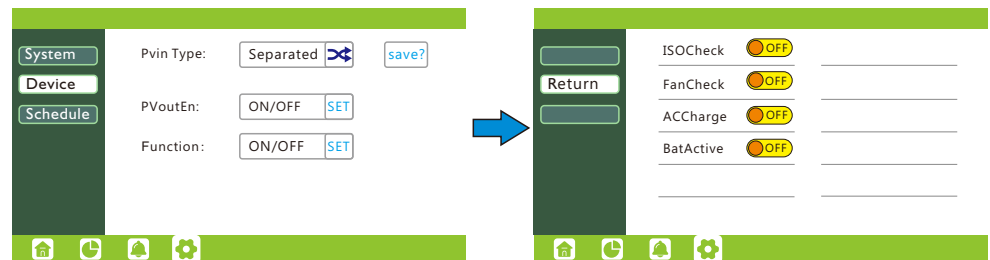

The function options in this navigation column are turned on and off for debugging. Please turn them off carefully, otherwise it may cause the machine to run abnormally or be damaged. Click "return" to return to the previous menu.

Running sequence settings

The running sequence setting is mainly for users to set the photovoltaic output power of the next day. The user can set the photovoltaic output power of the next day to output the corresponding power value at the corresponding time.

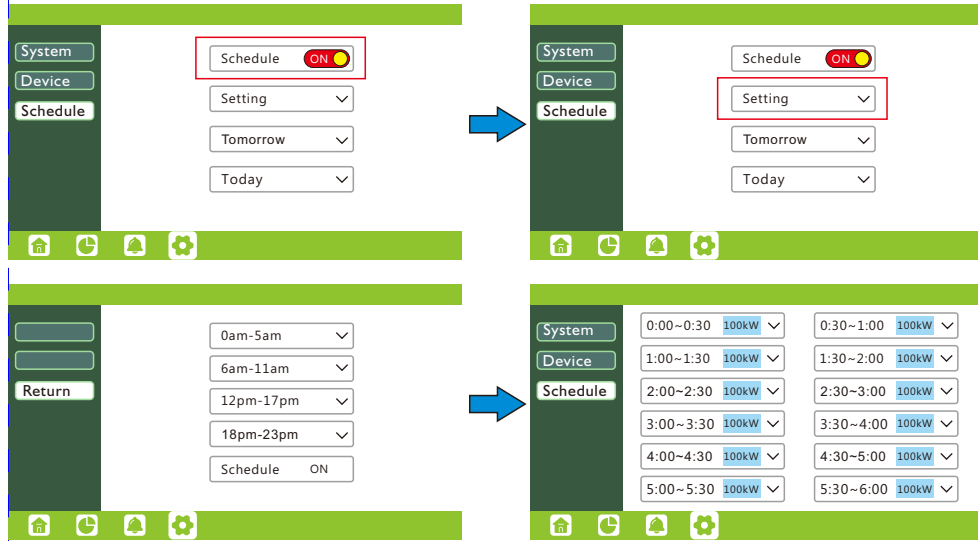

Step 1: Enable schedule and select ON switch.	Step 2: Click "setting" to enter the time bar, as shown in picture 3 above
Step 3: After choosing which time period settings to change, enter picture 4	Step 4: After changing the power in picture 4, click "return" to return, and click save in "schedule Save" to save.
Step 5: Click "return" and observe whether the settings for the next day have been set successfully in "tomorrow"	Step 6: User can check whether the setting of today are consistent with the previous setting.

7.5 Monitor System

Users can use wifi/GPRS/4G dongle to monitor the energy storage system, The monitor website is: server.luxpowertek.com The APP is also available in the google play and apple APP store(Scan two code bar to download the APP).

Please download the introduction of guidance by website: <https://www.luxpowertek.com/download/>

Document Reference:

1. Wifi Quick Guidance. Quick guidance for setting password for wifi module, the paper is also available in the wifi box.
2. Monitor system setup for Distributors and Monitor system setup for endusers. Monitor system registration ,wifi password setting, and wifi local monitor and setting.
3. Lux_Monitor_UI_Introduction. Introduction of monitor interface.
4. Website Setting Guidance. Introduction of website settings for LSP100K.
5. GPRS and 4G. The use of GPRS and 4G is similar to WIFI.

8. Shut down and Remove the Converter

8.1 Shut down the converter

Under normal circumstances, there is no need to shut down the converter, but when maintenance or repair work is required, the converter needs to be shut down. Please follow the steps below to disconnect the converter, otherwise it may cause personal injury or equipment damage.

- Step1. turn off PV input breaker of PV inverter side
- Step2. turn off the PV input breaker of Converter
- Step3. turn off the battery ,and waiting for the LCD goes off
- Step4. Use a current clamp to check the DC cable and confirm that there is no current.
- Step 5 Use the MC4 wrench to loosen the lock of the DC connector and remove the DC connector
- Step 6 Use a multimeter to confirm that the battery terminal terminal block is not live, Remove battery cables and communication cables
- Step 7 Install the MC4 waterproof plug.

8.2 Remove the converter

Risk of burns and electric shock!

After the Converter is completely disconnected from the photovoltaic inverter, battery and photovoltaic components, you need to wait for 5 minutes before you can touch the internal conductive components

- Step 1 Refer to "Electrical Connections" and follow the reverse steps to disconnect all electrical connections of the converter
- Step 2 Refer to "Installation" and follow the reverse steps to remove the converter
- Step 3 If necessary, remove the back plate from the wall.
- Step 4 If the converter will be used in the future, please refer to "Storage" to keep the converter properly

9. Troubleshooting & Maintenance





9.1 Troubleshooting

When faults and errors occurred, please deal with these problems following below procedures and requirements.

Code	Description	LCD Display	Troubleshooting
E002	Internal fault	E002	Restart LSP100K system, if the error still exist, please contact us
E003	Internal temperature out of range	E003	Observe whether the air duct of the machine is blocked, and whether the installation environment is as required in Chapter 5
E004	BAT voltage out of range	E004	1.Check whether the power connection cable of the battery is secure. 2.Check the BMS operation parameter
E005	BMS communication fault	E005	1.Check whether the communication cable between the battery and the converter is firmly connected 2.Check whether the communication cable is a straight-through line that meets the requirements 3.Check the BMS operation parameter
E006	BMS fault	E006	Check the BMS operation parameter
E007	Soft start fault	E007	Check the PVin and PVout connection , Restart LSP100K system, if the error still exist, please contact us
E010	Internal com MdspRxM fault	E010	Restart LSP100K system, if the error still exist, please contact us.
E011	MSDSP bus voltage out of range	E011	1.Check if the input voltage of PVin and battery is within the range 2.Restart LSP100K system, if the error still exist, please contact us.
E017	Internal com SdspRxM fault	E017	Restart LSP100K system, if the error still exist, please contact us.
E020	PV ISO fault	E020	Check the PVin connection ,Check whether the PV access cable is damaged
E025	Internal congfig fault	E025	Reset config setting, if the error still exist, please contact us.
E026	Internal com RxSdsp fault	E026	Restart LSP100K system, if the error still exist, please contact us.
E027	Internal com RxMdsp fault	E027	
E029	Model Fault	E029	Check the LSP100K model configuration, Restart LSP100K system, if the error still exist, please contact us.

W001	PV out volt high	W001	Check the PV output connection, Check the output voltage. Restart LSP100K system, if the warning still exist, please contact us.
W002	PV out current high	W002	Check the PV input connection, Check whether the output is short-circuited, and check whether the input of the photovoltaic inverter is short-circuited Restart LSP100K system, if the warning still exist, please contact us.
W004	PV out temperature high	W004	1.Observe whether the air duct of the machine is blocked, and whether the installation environment is as required in Chapter 5 2.Observe whether the fan of the machine is operating normally
W009	PV in volt high	W009	Check the input PV voltage of the machine, check whether the number of input PV panels in series is too much
W010	PV in current high	W010	1.Check whether the parameters input by the PV panel meet the specifications of the machine 2.Check whether there is a short circuit in the machine
W012	PV in temperature high	W012	Observe whether the air duct of the machine is blocked, and whether the installation environment is as required in Chapter 5 Observe whether the fan of the machine is operating normally
W014	PV in SPD warning	W014	Check whether the lightning protection module part of the machine is damaged
W015	PV in string reverse	W015	Check and fix PV input connection, Restart LSP100K system, if the warning still exist, please contact us.
W025	BMS Warning	W025	Check the BMS operation parameter
W026	Meter communication fault	W026	Check the meter connection, if the warning still exist, please contact us.
W027	Fan check fail	W027	Check fan connection and fan blade, if the warning still exist, please contact us.
W028	Lcd communication fault	W028	Restart LSP100K system, if the warning still exist, please contact us.

9.1.1 Introduction to LED Displays

LED	Display	Description	Suggestion
Green LED	Long light 	Working normally	
	Flashing 	Firmware upgrading	Wait till upgrading complete
Yellow LED	Long light 	Warning, inverter working	Need troubleshooting
Red LED	Long light 	Fault, inverter stop work	Need troubleshooting

9.2 Maintenance

DANGER

Improper maintenance operations may cause personal injury or equipment damage, Before performing any maintenance operations, the following steps must be followed:

1. First turn off the input PV switch on the PV inverter side, then turn off the PV input DC switch of the LSP100K machine, and finally turn off the battery switch.
2. Wait at least 5 minutes until the internal energy storage components are discharged before performing maintenance or overhaul operations inside the equipment.
3. Use testing equipment to check to ensure that there is no voltage and current.

WARNING

When performing electrical connection and maintenance work, temporary warning signs or barriers must be posted to prevent unrelated persons from entering the electrical connection or maintenance area.

NOTICE

1. The system can be restarted only after troubleshooting the fault that affects the safety performance of the LSP100K system.
2. The inside of the converter does not include repairs, please do not replace the internal components of the converter without authorization.
2. If you need any maintenance service, please contact LUX power after-sales service center. Otherwise, LUX POWER will not bear any warranty and joint liability for the losses caused thereby

NOTICE

Touching the printed circuit board or other electrostatic sensitive components may cause damage to the device.

1. Avoid contact with unnecessary circuit boards.
2. Observe the ESD protection regulations and wear an anti-static wristband.

9.2.1 Regular Maintenance And Recommended Maintenance Cycle

Inspection Items	Inspection Method	Recommended maintenance period
System cleaning	1.Check whether there is dust and other blockages attached to the machine's air inlet, outlet and heat sink. 2.If necessary, clean the air inlet and outlet and the heat sink	Half a year to once a year (Depends on the amount of local dust)
Fan	1.Check whether the fan makes abnormal noises when it is running 2.Whether the fan speed meets the requirements 3.Whether the fan blades of the fan are damaged, cracked or broken. 4.If necessary, replace the fan, (please refer to 9.2.2 for replacement details)	Once a year
Equipment inlet hole	Check whether the machine inlet hole is incompletely blocked or has a large gap. If so, re-block it. Avoid condensation of water inside the machine.	Once a year
Electrical connections	1.Check whether the cable connection is loose or disconnected. 2.Check whether the cable is damaged, especially whether there is a cut in the contact with the metal.	Once a year

9.2.2 Fan Maintenance

DANGER

1. First turn off the input PV switch on the photovoltaic inverter side, then turn off the PV input DC switch of the LSP100K machine, and finally turn off the battery switch
2. Wait at least 5 minutes until the internal energy storage components are discharged before performing maintenance or overhaul operations inside the equipment
3. The maintenance and replacement of the fan must be performed by professionals.

The fan of the converter cools and dissipates the heat of the machine to ensure the normal operation of the machine. If the fan does not work properly, it will cause the system to work abnormally. Therefore, it is necessary to keep the fans clean and maintain the problematic fans in a timely manner. The steps for replacing the fan are as follows:

1. Turn off the converter system.
2. Loosen the screw on the fan cover on the left side of the fuselage.

Refer to the following picture:

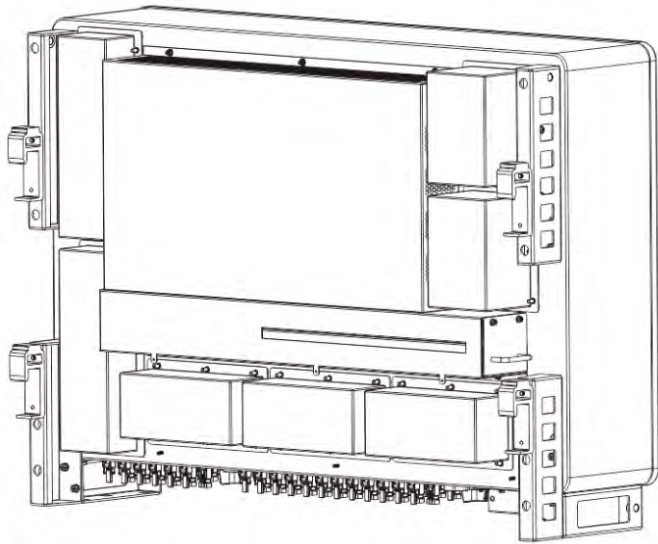

3. Pull the fan tray out slightly until the fan power connector is exposed, press down on the protrusion of the fan power connector and pull it out.

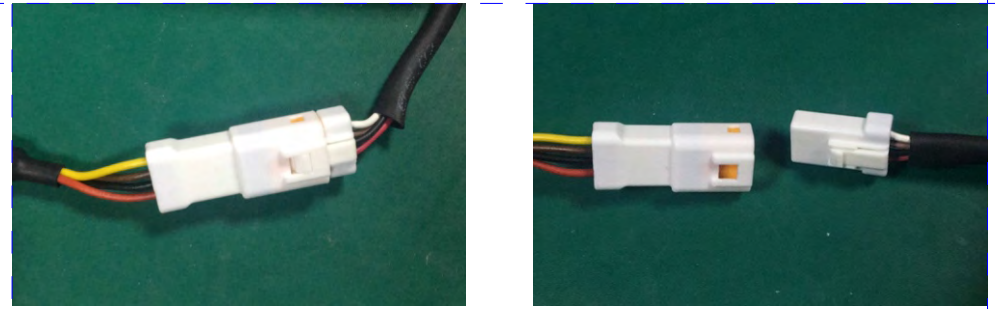
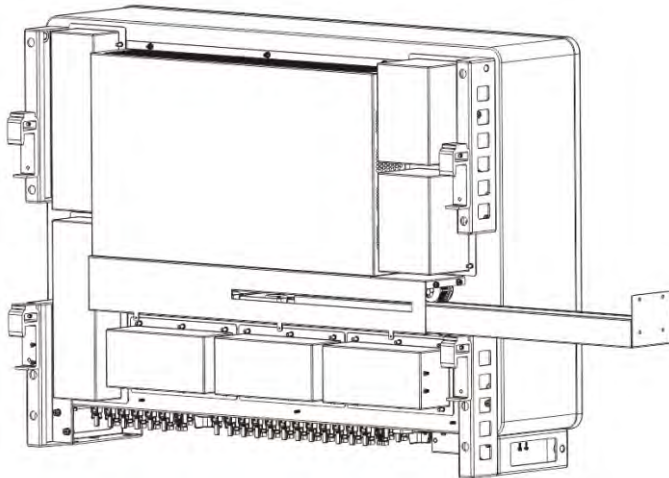

4. Pull out the fan bracket completely, and use a soft brush to clean the fan or replace a damaged fan.

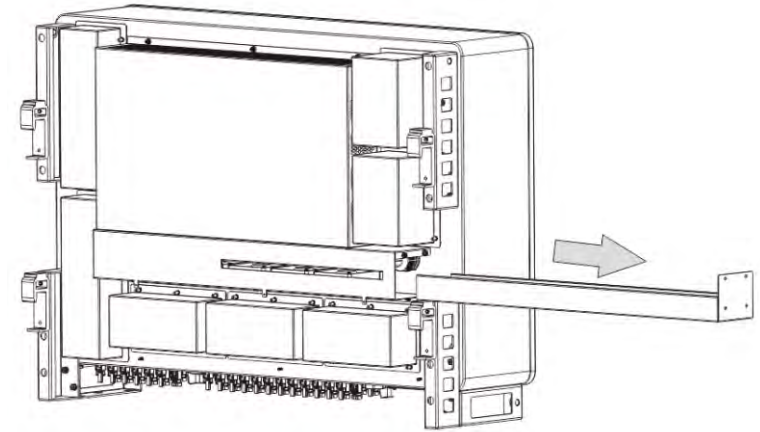

5. In the reverse order as above, reinstall the maintained fan back to the converter and restart the system

10. Product Specification

Input data	LSP100K
Max. input voltage	1,100V
Input nominal voltage	630V
Input voltage range	300-1000V
Start voltage	330V
Max. short current per MPPT	40A
Max. current per MPPT input	26A
Number of MPPT tracks	12
Number of input strings	24

Output data

DCDC Output rated power	100kW
Normal output voltage	630V
Output voltage range	500~1000V
Max output current	20A
Output strings	12
Output tracks	12

Battery data

Type	Lead-acid/Lithium
Max. charge and discharge power	100kW
Voltage range	300~700Vdc
Max. charge and discharge current	200A
Communication	CAN or RS485
Max. charge and discharge efficiency	98.5%

Protection

DC Reverse-polarity Protection	Yes
DC Surge Arrester	Type II

Communication

Display	LED+LCD
Operation	Touch botton
Wifi/4G	Yes

General Data

Dimensions(W*H*D)	1015*680*310
Weight (with mounting plate)	120KG
Protection Degree	IP 65
Topolgy	Transprmerless
Cooling Method	Air cooling
Relative Humidity	0%~100% Relative Humidity(Non-codensing)
Operating Temperature Range	-25℃~60℃
Connector(PV input and output)	MC 4
Battery connector	Screw
Max. Operating Altitude	4000m
Warranty	5years

11. Appendix

11.1 Quality Warranty

For products that fail during the warranty period, LUX power tek (hereinafter referred to as our company) will repair or replace the product. If you need to repair or replace the product, please show the invoice and date of purchase.

Liability exemption

The company reserves the right not to guarantee quality in the following situations:

- 1.Incorrect installation, modification or use.
- 2.Exceeding the harsh conditions of use described in this manual
- 3.Machine failure or damage caused by changes, disassembly, etc. not authorized by the company.
- 4.Anything beyond the scope of installation and use specified in the relevant international standards.
- 5.Damage caused by unforeseen natural disasters

11.2 Contact Information

If you have technical problems with the product, please contact your installer or LUX POWER.

When inquiring, please provide the following information

- 1.Serial number of the converter
- 2.The error message code on the LCD of the converter
- 3.System wiring diagram
- 4.Converter input, output voltage
- 5.The communication method of the converter, etc

ShenZhen Lux Power technology Co., LTD

<http://www.luxpowertek.com>

E-Mail: service@luxpowertek.com

Add: 5th floor, A Zone of Building 11, Hengchangrong High-Tech Industrial Park, Huangtian Comunity, Hangcheng Street Bao'an District, Shenzhen, China