

 Deutsche
 Qualität
 Garantiert



120

HALF
CELLS

210
mm

CELL
SIZE



LID
RESISTANT



PID
RESISTANT



SALT CORROSION
RESISTANT



SAND
RESISTANT



AMMONIA
RESISTANT



HIGHLY STABLE
AND TOUGH

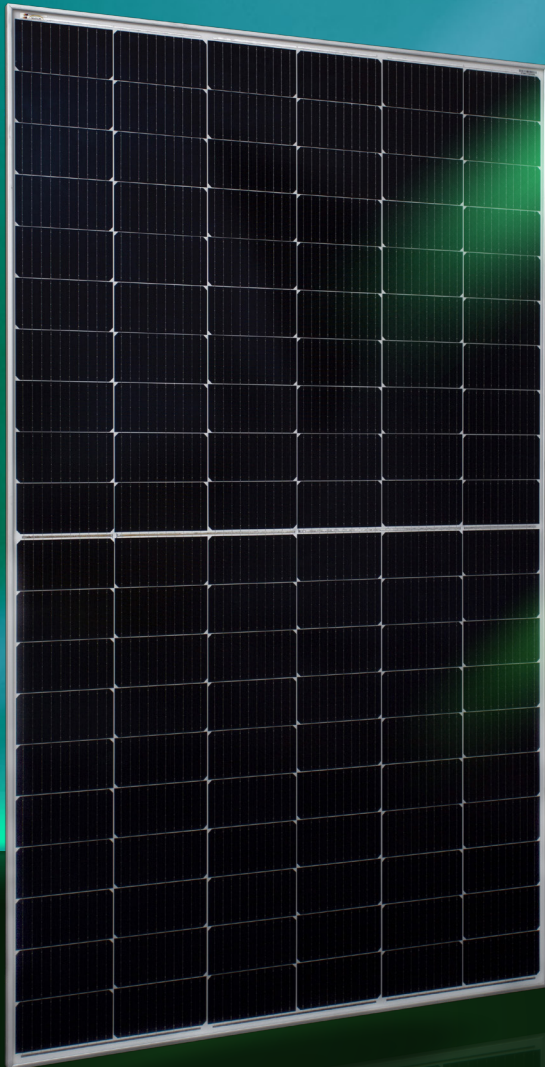

AURORA

HIGH ENERGY YIELD
RELIABILITY
DURABILITY

30

years

Performance
Guarantee

15

years

Product
Warranty

MONO-CRYSTALLINE PV MODULES
HALF-CUT CELLS • BIFACIAL • SINGLE-GLASS

585W-605W

AE ME-120BS Series



IEC 61215
IEC 61730
Regular Production Surveillance
Type Tested and Monitored

IEC 62716 (Ammonia corrosion)
IEC 61701 (Salt mist corrosion)
IEC 60068 (Sand and dust)
IEC 62804 (PID resistance)

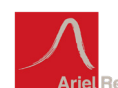

www.ae-solar.com

Mechanical and design specification

Cell type	Gallium-doped Mono c-Si PERC, Half-cut cells, 210 mm
No. of cells	120
Glass	3.2 mm, high transmission, AR coated, tempered
Bifaciality	70±5%
Encapsulation	EVA
Back cover	Transparent Backsheet
Junction box	IP 68 rated
Frame	35 mm anodized Aluminium alloy
Cable	1 x 4 mm ² , 350 mm length or customized
Connectors	MC 4 / MC 4 compatible
Dimension	2172 mm x 1303 mm x 35 mm
Weight	30.9 kg
Hail resistance	Max. Ø 25 mm at 23 m/s
Wind load	2400 Pa/ 244 kg/ m ²
Mechanical load	5400 Pa/ 550 kg/ m ²

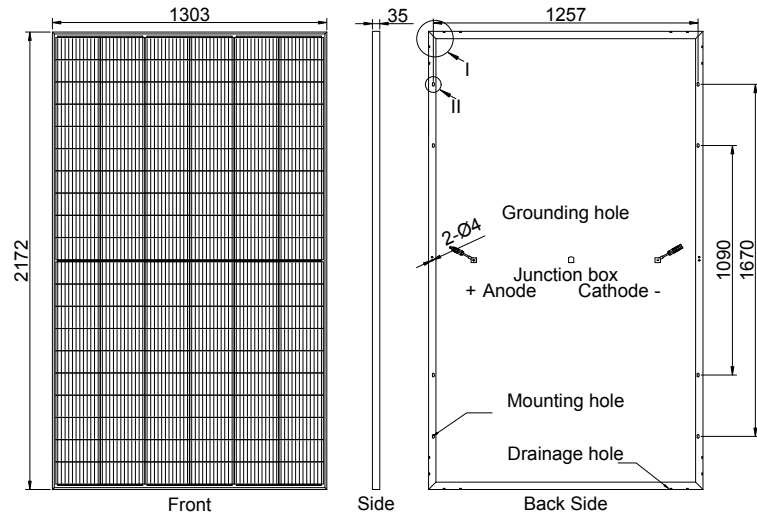

Packaging information

Packaging configuration	31 pcs / pallet
Loading capacity	527 pcs / 40 HQ
Size / Pallet	1350 mm x 1145 mm x 2310 mm (Stand on end)
Weight	996 kg / pallets

Temperature ratings

Operating temperature	(°C)	-40 to +85
Temp.coefficient of P _{max}	(%/°C)	-0.34
Temp.coefficient of V _{oc}	(%/°C)	-0.25
Temp.coefficient of I _{sc}	(%/°C)	0.04
Nom. operating temp. NOCT	(°C)	43 ± 2

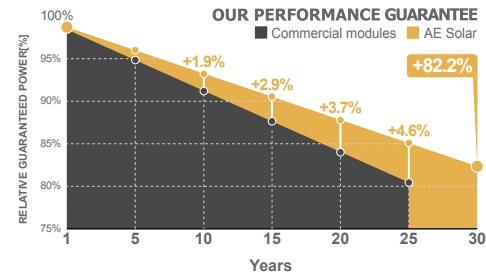
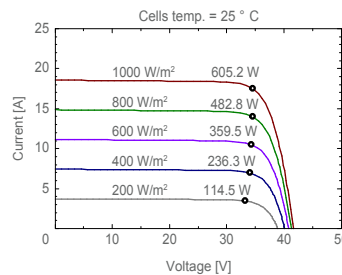
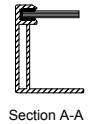
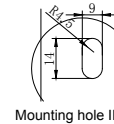
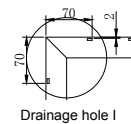

Electrical specifications (STC*):		AE585ME-120BS	AE590ME-120BS	AE595ME-120BS	AE600ME-120BS	AE605ME-120BS
Nominal Max. Power	P _{max} (Wp)	585	590	595	600	605
Maximum operating voltage	V _{MPP} (V)	33.80	34.00	34.20	34.40	34.60
Maximum operating current	I _{MPP} (A)	17.31	17.35	17.40	17.44	17.49
Open-circuit voltage	V _{oc} (V)	40.90	41.10	41.30	41.50	41.70
Short-circuit current	I _{sc} (A)	18.37	18.42	18.47	18.52	18.57
Module efficiency	η (%)	20.70	20.80	21.02	21.20	21.40
Power tolerance	(W)			0~+5		
Maximum system Voltage	(V)			1500		
Maximum series fuse rating	(A)			30		

*STC: Standard test conditions (Irradiance 1000 W/m², Cell temperature 25°C and air mass of AM1.5)

Electrical specifications (NMOT*):		AE585ME-120BS	AE590ME-120BS	AE595ME-120BS	AE600ME-120BS	AE605ME-120BS
Nominal Max. Power	P _{max} (Wp)	440	444	448	452	456
Maximum operating voltage	V _{MPP} (V)	31.80	32.00	32.20	32.40	32.60
Maximum operating current	I _{MPP} (A)	13.85	13.88	13.92	13.95	13.99
Open-circuit voltage	V _{oc} (V)	38.10	38.30	38.50	38.70	38.90
Short-circuit current	I _{sc} (A)	14.70	14.74	14.78	14.82	14.86

*NMOT: Normal Module Operating Temperature (Irradiance 800 W/m², Ambient temperature 20°C, air mass of AM1.5 and wind speed of 1 m/s)

The specifications and characteristics contained in this datasheet may deviate slightly from our actual products due to the product developments and uncertainty of measurement devices. The specifications included in the datasheet are subject to change without prior notice.