



INSTALLATION & OPERATION MANUAL

REV.2023.1

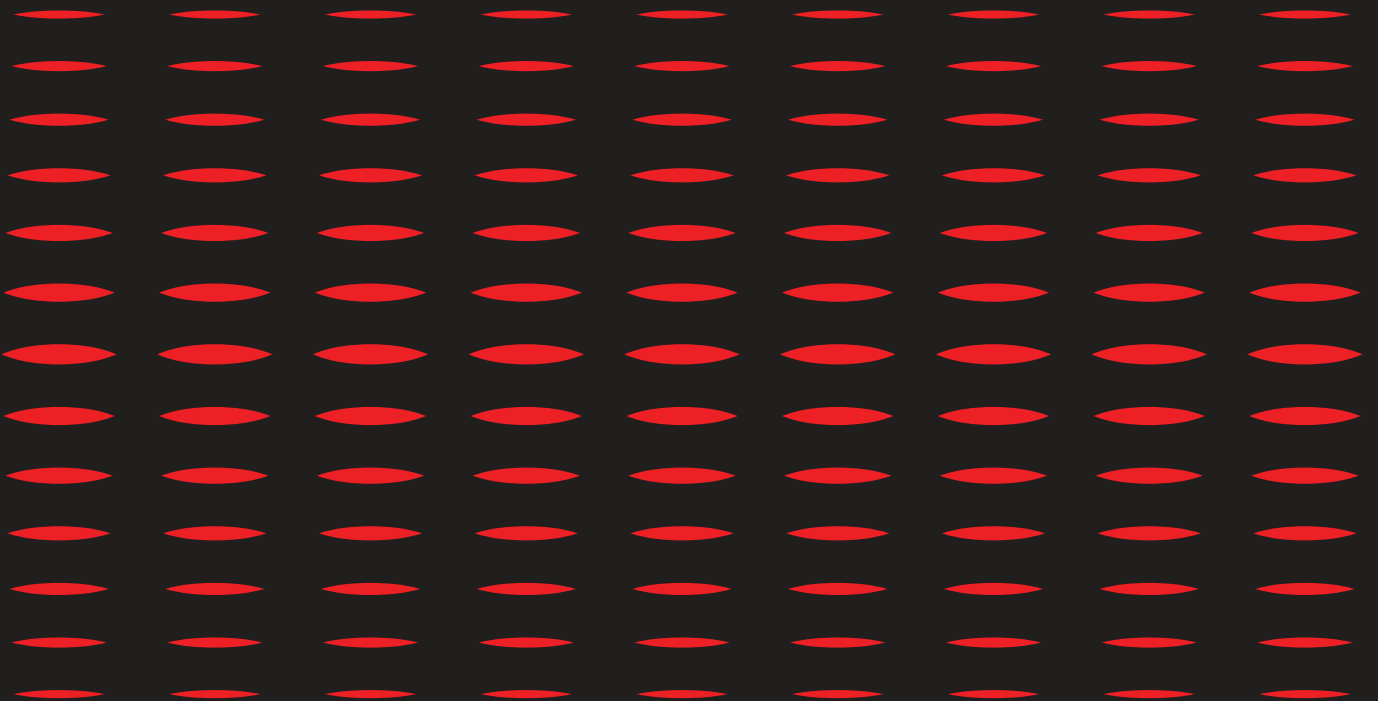

TABLE OF CONTENTS

1. INTRODUCTION	2
1.1. OVERVIEW	2
1.2. SCOPE OF LIABILITY	2
2. LAWS AND REGULATIONS	2
3. SAFETY PRECAUTIONS	2
3.1. GENERAL SAFETY	2
3.2. OPERATION SAFETY	3
4. TRANSPORT, UNPACKING, AND STORAGE	7
4.1. TRANSPORT	7
4.2. UNPACKING	8
4.3. STORAGE	8
5. MECHANICAL INSTALLATION	9
5.1. ENVIRONMENT CONSIDERATIONS	9
5.2. MOUNTING	10
5.2.1. FIXED MOUNTING SYSTEM	11
5.2.2. TRACKING MOUNTING SYSTEM	13
6. ELECTRICAL CONNECTION	13
6.1. SIZING AND INTERCONNECTIONS	14
6.2. WIRING	14
6.3. FUSING	15
6.4. GROUNDING	15
7. CHECK LIST	16
8. MAINTENANCE	18
8.1. CLEANING	18
8.2. VISUAL INSPECTION	18

1. INTRODUCTION

Thank you for choosing AE Solar. To ensure the maximum performance of your AE Solar photovoltaic modules, please read all the following instructions carefully and abide by all guidelines. Failure to follow these instructions may result in death, injury, or property damage. The installation and handling of modules require professional skills and should only be performed by qualified personnel.

1.1. Overview

This installation and operation manual (hereafter also referred to as the “Manual”) provides important safety information regarding the installation, handling, mounting, wiring, and maintenance of AE Solar photovoltaic modules. Please ensure that this Manual is available to the operator at all times. It is the installer’s duty to notify the end-user (consumer) of the aforementioned information accordingly.

Please retain this Manual for future reference. This Manual should be passed on to all subsequent owners or users of the solar modules. If any questions are not satisfactorily answered within the Manual, please contact your system supplier. The most updated version of this Manual and additional information can be readily found at www.ae-solar.com

1.2. Scope of Liability

AE Solar gives no warranty of any kind whatsoever, either explicitly or implicitly, with respect to the information contained in this Manual.

The installation, handling, and use of AE Solar’s modules are beyond company control. AE Solar assumes no responsibility for loss, damage, injury, or expense resulting from the improper installation, handling, use or maintenance of modules. Any misuse or incorrect use of AE Solar modules voids the limited warranty and may create a safety hazard and risk property damage. This includes improper installation or configuration, improper maintenance, unintended use, and unauthorized modification.

AE Solar assumes no responsibility for any infringement of patents or other rights of third parties that may result from use of the modules.

AE Solar reserves the right to update any information within this Manual without prior notice. In the event of inconsistencies between the different language versions of this Manual, the English version shall prevail.

2. LAWS AND REGULATIONS

The mechanical and electrical installation of the PV modules should be done in accordance with the local laws, regulations, and standards. This includes any electrical codes, construction codes, and electrical connection requirements. These regulations may vary with the system installation type, e.g. rooftop systems, floating PV systems, etc., as well as with system voltage. Please contact local authorities for information regarding the governing regulations.

3. SAFETY PRECAUTIONS

3.1. General Safety

All instructions should be read and understood before installing, wiring, operating, and/or maintaining the modules and other electrical equipment. PV modules generate direct current (DC) when exposed to sunlight or other light sources. Direct contact with electrically active parts of the module can result in burns, sparks, injury, or death. Please be sure to isolate live circuits before attempting to make or break any connections.

Before installing, please make sure the local requirements for installation are met. Contact the relevant local authority if necessary. The installation process should comply with the safety regulations applicable to all the system’s components, including but not limited to cables, terminals, charging monitors, batteries, inverters, etc.

The installation and maintenance of PV modules and systems must be done by licensed electricians or other qualified personnel. **Do NOT** allow unauthorized persons near the installation site or module storage area.

Personal protective equipment must be worn during installation, including but not limited to protective headgear, insulating gloves, and safety shoes with rubber soles. Electrically insulated tools should be used to reduce the risk of electric shock. Prior to installation, remove all metallic jewelry to prevent accidental exposure to live circuits.



3.2. Operation Safety

- ! Once the PV module has been shipped to the installation site, all of the parts should be unpacked properly with care.

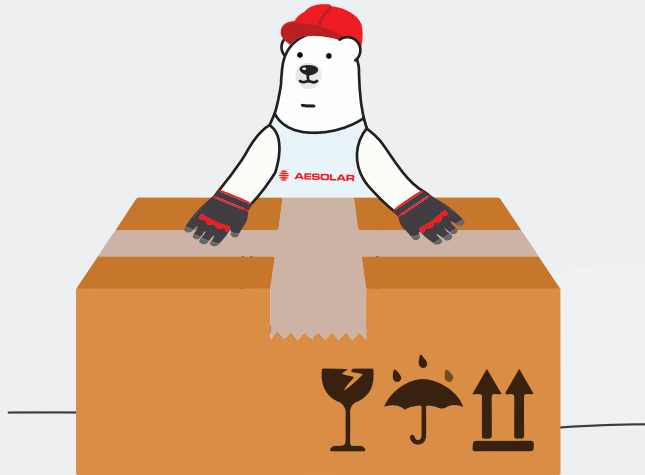

Fig. 1

- ! **Do NOT** install modules during strong winds or other hazardous weather conditions.

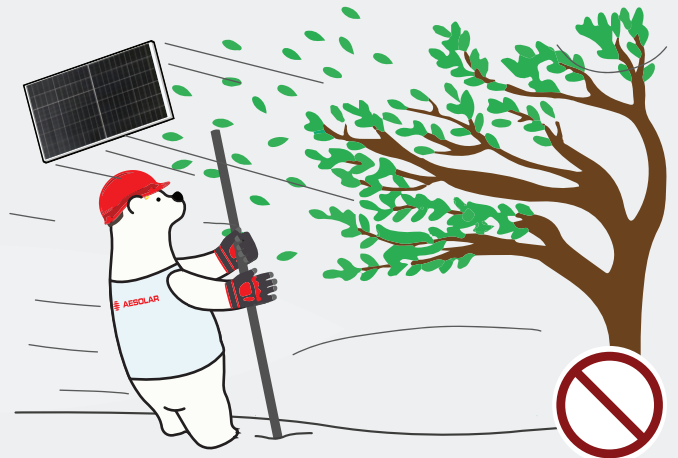

Fig. 2

- ! When installing modules in light rain, please take appropriate measures to prevent water from entering the connectors.



Fig. 3

- ! Any installation for altitudes over 2000 m should be discussed and approved by AE Solar.

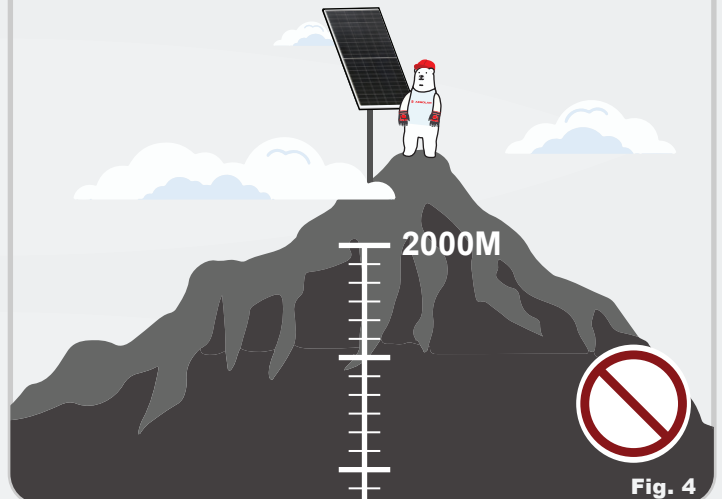

Fig. 4

- ! **Do NOT** install modules indoors or on moving objects (except for trackers).

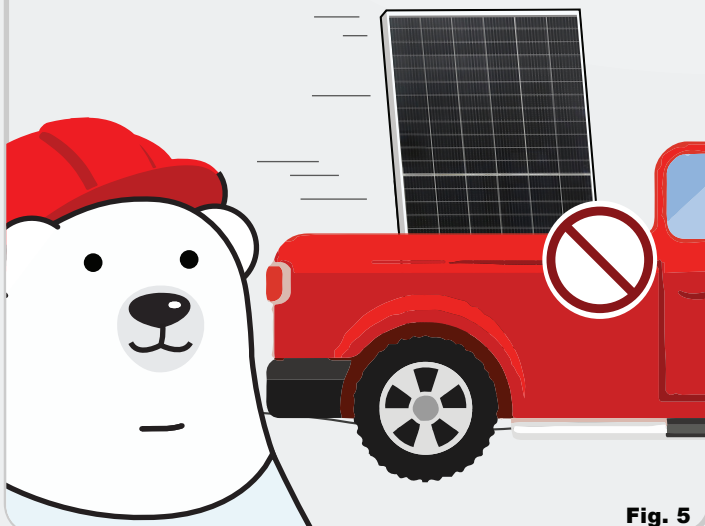

Fig. 5

- ! Contact with any broken module surface or frame can lead to electrical shock. **Do NOT** install or use a module with broken glass or torn substrate.

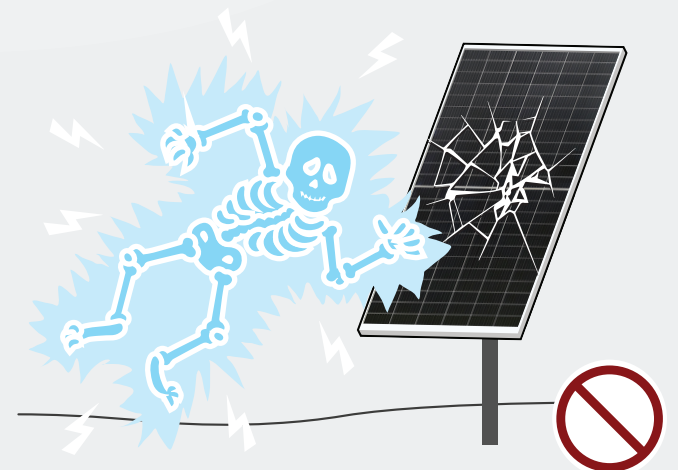

Fig. 6

3.2. Operation Safety

- ! **Do NOT** attempt to disassemble the modules or remove/repair any module parts. Any broken modules should be replaced immediately.

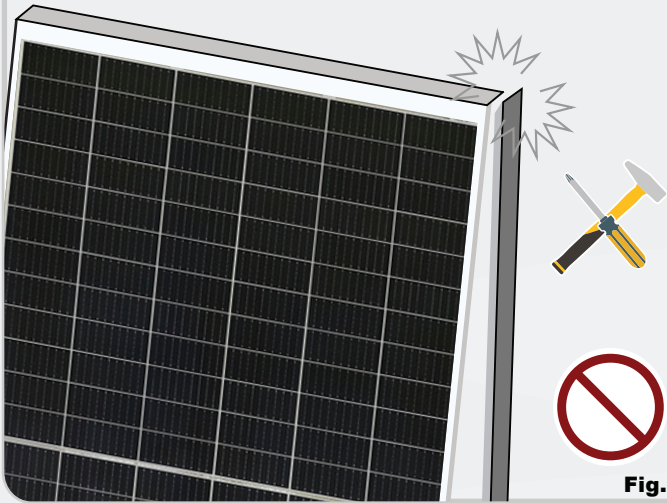

Fig. 7

- ! **Do NOT** stand, step on, damage, or scratch the front or back surfaces of the module. Localized heavy loads may cause severe micro-cracks at the cell level, which may affect module reliability and void the warranty.



Fig. 8

- ! **Do NOT** drop any objects onto the modules or subject them to any mechanical stress.

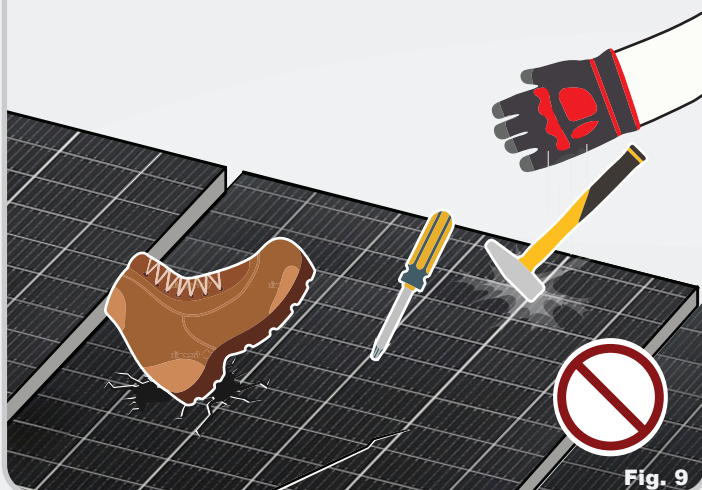

Fig. 9

- ! **Do NOT** place excessive loads on the modules or twist the modules' frames.



Fig. 10

- ! **Do NOT** drill holes in the module frame. It may decrease frame loading capacity and cause corrosion of the frame.



Fig. 11

- ! **Do NOT** paint or apply any other adhesive onto the modules.

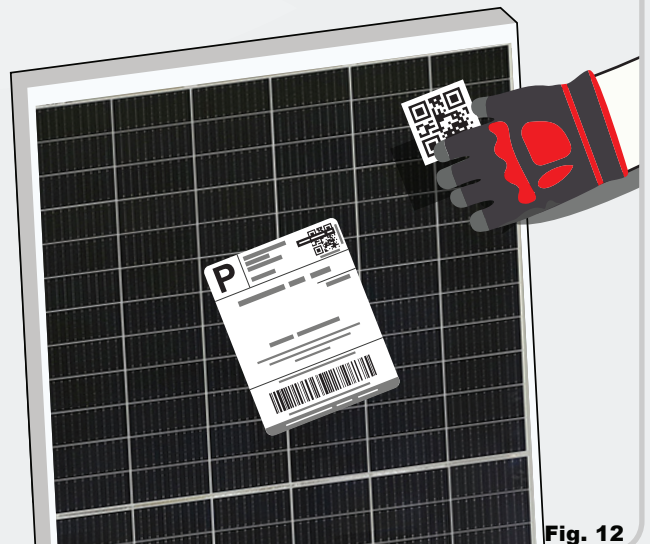

Fig. 12

3.2. Operation Safety

! Keep the junction box cover closed at all times.

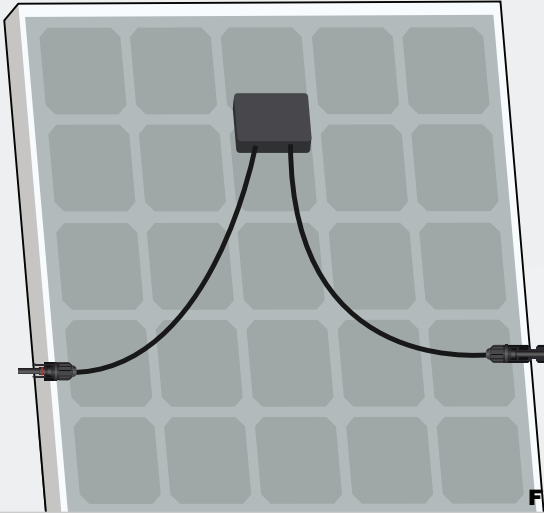

Fig. 13

! Do NOT focus artificially concentrated sunlight onto the modules.



Fig. 14

! Make sure that all connectors are clean, dry, and free from corrosion before making the connection.

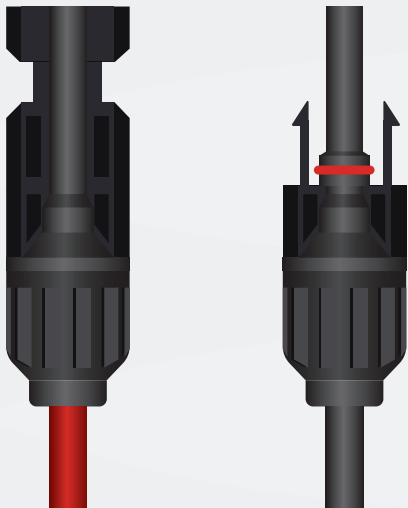

Fig. 15

! When installing PV modules in deserts or windy and sandy areas, AE Solar recommends the use of connector dust caps before installation, or other measures to prevent sand and dust from entering the connectors. This is important to prevent potential insertion problems or electrical safety hazards.

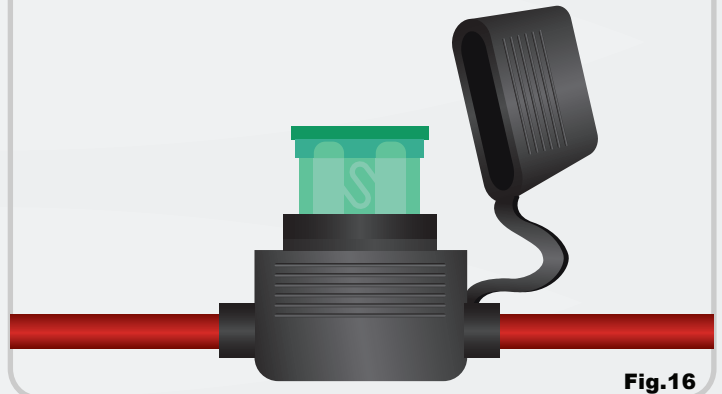

Fig. 16

! Ensure that all connections are securely made with no gap between the contacts. An audible "click" sound should be heard to confirm the connectors are fully sealed. Any gaps may result in electrical arcing, which can cause fire hazards and/or electrical shocks.

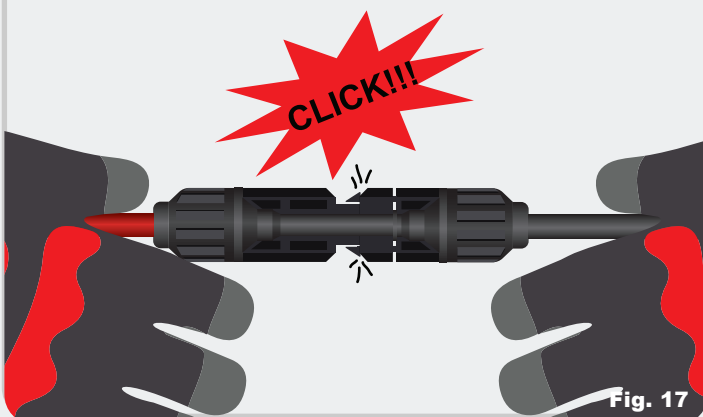

Fig. 17

! Do NOT disconnect any modules under load to avoid arcing and electrical shocks. If necessary, the PV array may be covered with an opaque material to stop the production of electricity and reduce the risk of electrical shock.

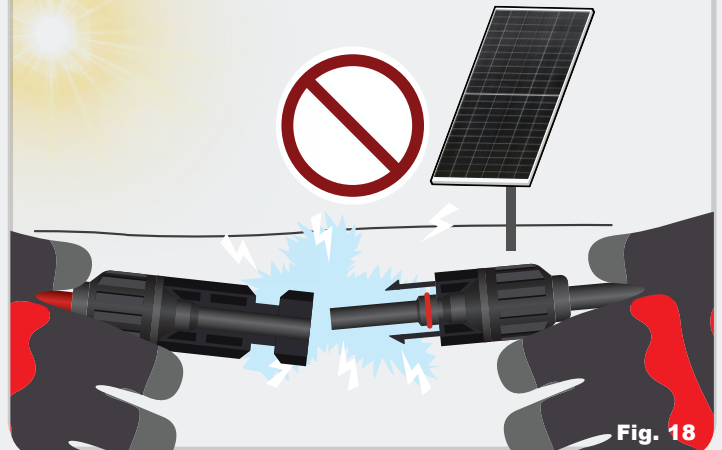

Fig. 18

3.2. Operation Safety

- ! Only panels of the same model should be connected in series.

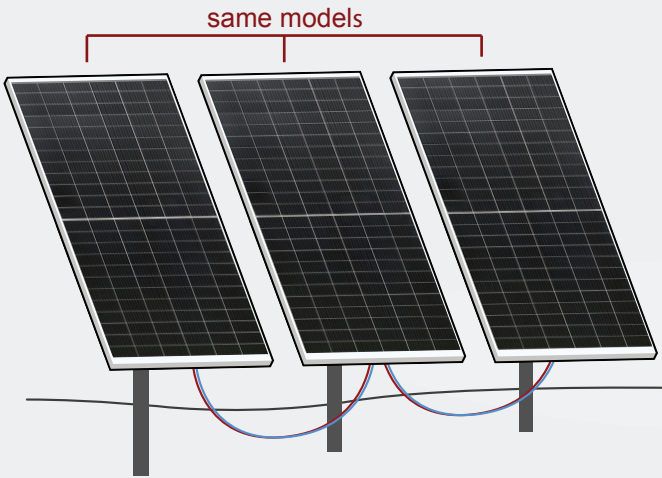

Fig. 19

- ! Avoid partial shading of the PV modules for extended periods of time. Partial shading of a PV module might lead to locally increased module temperature and increases the risk of hotspot formations. Hotspots reduce the lifetime of the PV modules and can lead to module failure.



Fig. 20

- ! **Do NOT** place PV modules near equipment or where flammable gas may be generated.



Fig. 21

- ! **Do NOT** use water to extinguish fires of electrical origin.



Fig.22

- ! **Do NOT** clean the module glass with chemicals. Only use desalinated water. Make sure the module surface temperature is cool to the touch. Cleaning modules with cool water when module surface temperature is high may result in glass breakage. Do not brush paint or corrosive substances on the surface of the modules.

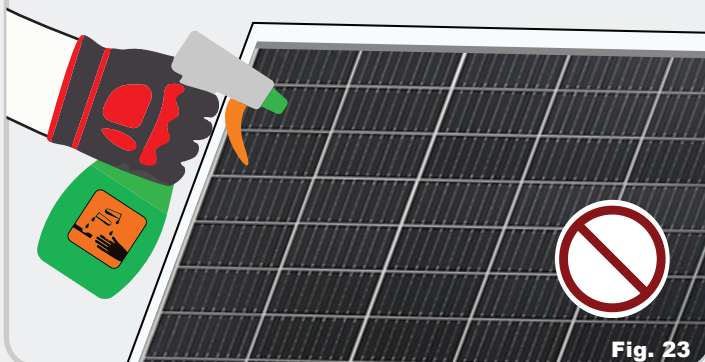

Fig. 23

- ! When looking at PV modules with anti-reflection (AR) coating technology, it will be normal to see some cells with a slight color difference at different angles.

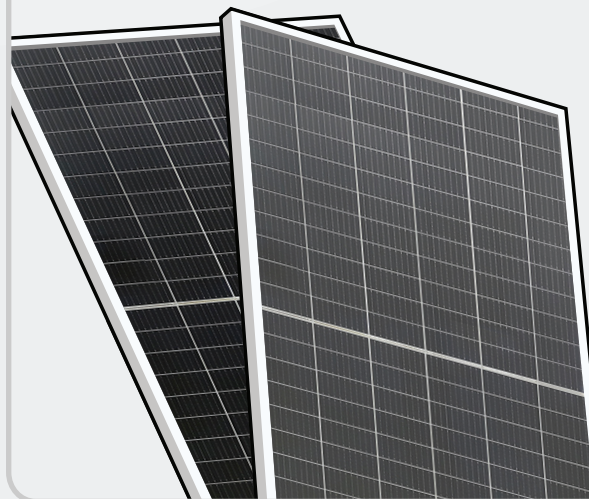
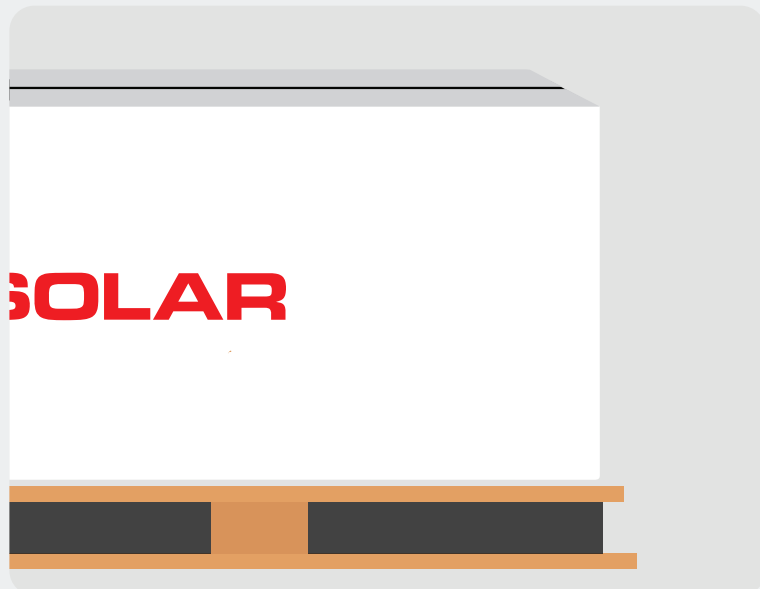

Fig. 24

4. TRANSPORT, UNPACKING AND STORAGE

4.1. Transport



When first receiving the modules, please verify that the product delivered is in fact the product ordered. The product name, serial number, and other relevant information can be found on the outside of each packing box.

To unload the module pallets from containers, please utilize a forklift. The forklift should be close to the ground to avoid contact between the top of module pallets and the top of the container door.

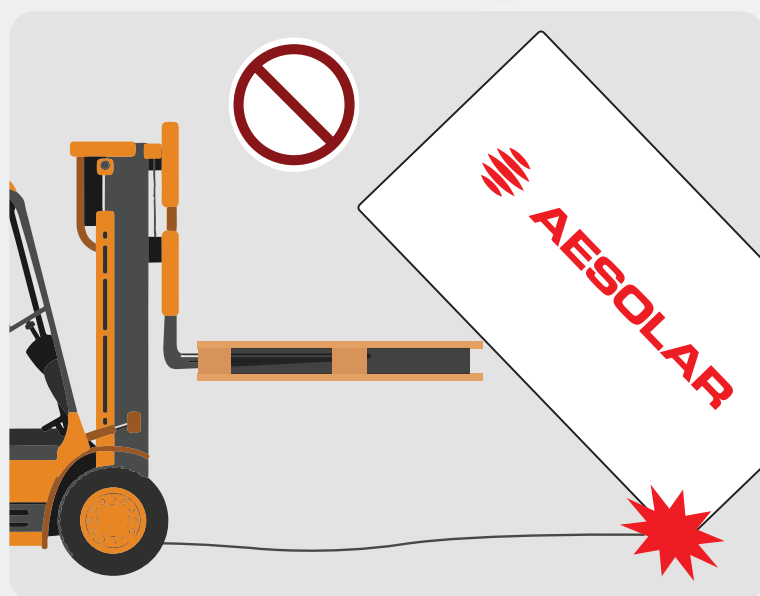
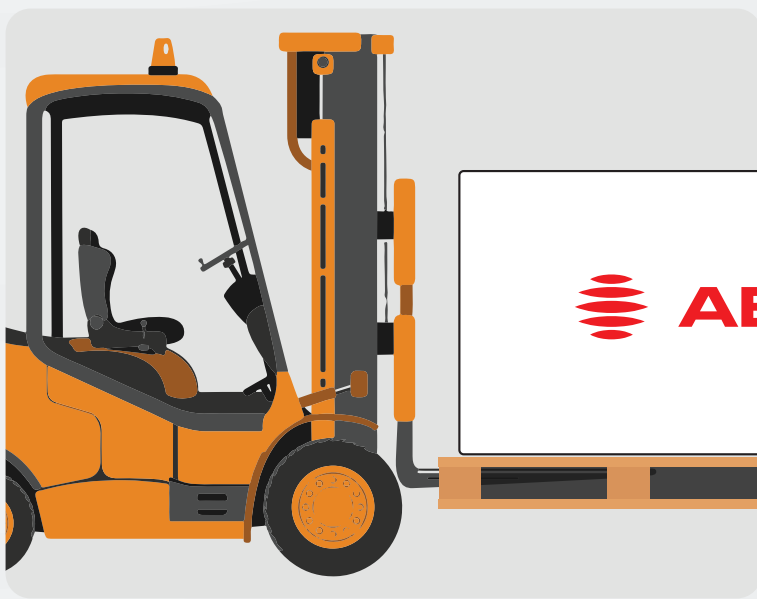

During transportation, never drop the module from a vehicle, house or hands. This will damage the module.

4.2. Unpacking

Make sure to leave the product in its original packing box until you are ready to install.

When unpacking, **Do NOT** use sharp instruments directly on the modules. Please ensure to avoid any damage to the module's backsheet via sharp objects, as any scratches or tearing may affect product safety.

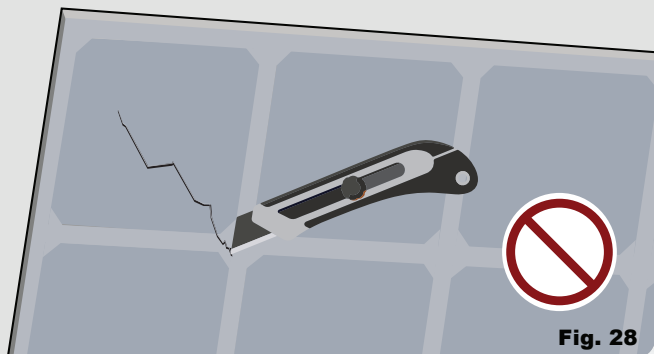

Modules must always be unpacked and installed by two people. Always use both hands when handling modules.

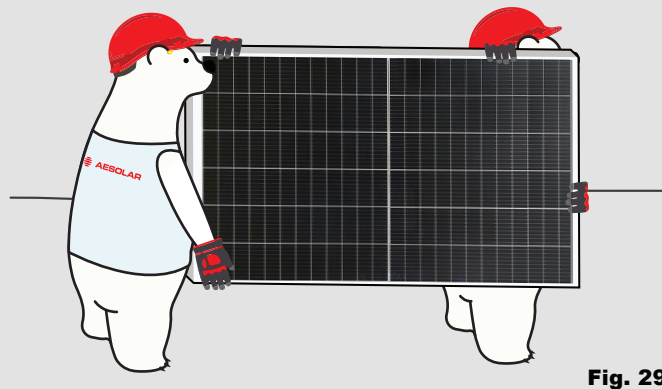

! Always carry modules upright and lifting them by the frame. **Do NOT** lift PV modules by the attached cables or the junction box. **Do NOT** carry modules on your head.

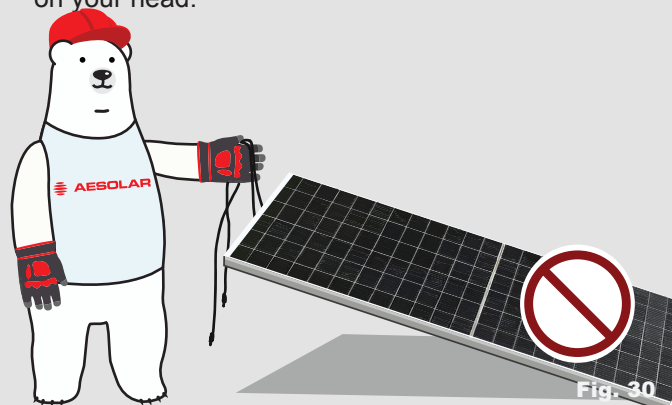

! **Do NOT** support the module by the backsheet when handling or installing the module.

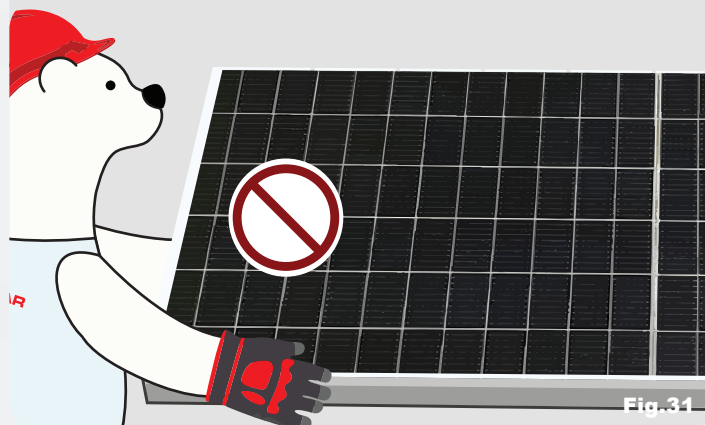

4.3. Storage

Modules should always be stored in a dry and ventilated environment with relative humidity below 85% and ambient temperatures between -20°C and 50°C . In an uncontrolled environment, the storage time for modules should be no longer than 3 months. In this case, extra precautions should be taken to prevent connectors from being exposed to moisture or sunlight.

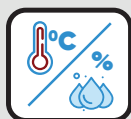

Modules (glass, junction boxes, connectors, etc.) must be protected from long-term exposure to any environments containing sulfur, strong acid/alkaline conditions, etc., which may pose a risk of corrosion to the product.



5. MECHANICAL INSTALLATION

Before installing the modules, please obtain any relevant information about the requirements and necessary approvals for the site, installation, and system inspection from the relevant authorities.

Applicable building codes should be checked to ensure that the construction or structure (roof, facade, support, etc.) can bear the module system load. Please consult the local authority for guidelines and requirements for the building's structural or fire safety.

5.1. Environment Considerations

Please make sure to install the modules under the following conditions:

- Ambient temperature: -40°C to $+50^{\circ}\text{C}$
- Operating temperature: -40°C to $+85^{\circ}\text{C}$
- Storage temperature: -20°C to $+50^{\circ}\text{C}$
- Humidity: $< 85\%$

For most applications, solar modules should be installed so as to receive maximum sunlight throughout the year. This typically means a south-facing orientation for the northern hemisphere, and a north-facing orientation for the southern hemisphere. Modules facing 30° away from true South (or North) will lose approximately 10 to 15 percent of their power output. If the module faces 60 degrees away from true South (or North), the power loss can be between 20 to 30 percent.

(Fig.34) When choosing the installation site, it is important to avoid any objects that may cast potential shadows on the PV modules, such as trees, buildings, or other obstructions. This is especially relevant during winter when the sun's path is lowest over the horizon. Module shading causes losses in power output, even though the module's bypass diodes minimize such losses. Constant shading conditions can also affect module lifetime, due to accelerated aging of the encapsulation material and thermal stress on the bypass diodes.

(Fig.35) The tilt angle of the PV module is measured between the surface of the PV module and a horizontal ground surface. The PV module will generate maximum power output when facing the sun directly. In grid-connected systems where the modules are attached to a fixed structure, the tilt angle should be selected to maximize energy production on an annual basis. In stand-alone systems with batteries, however, the tilt angle of the modules should be selected to optimize the performance based on seasonal load and sunlight. In general, this means that if the system's output power is adequate when irradiance is low (e.g., winter), then the chosen angle should be adequate throughout the year. Modules connected in the same string should be installed with the same orientation and tilt angle. Different orientations and tilt angles may result in different received solar irradiation and output power loss.

This means the modules can be safely installed in corrosive salt areas within proximity of the ocean or sulfurous areas, as well as in ammonia-heavy environments, such as farmhouses. In the case of highly corrosive environments (e.g., near the ocean) make sure to protect the connectors or add dust plugs. After removing the dust plugs, connect the connectors immediately and take any other necessary anti-corrosion measures to prevent rust. AE Solar also recommends stainless steel or aluminium materials be used in the areas with direct contact with the PV modules.

(Fig.36) AE Solar recommends a minimum tilt angle of 10° , so module surface dust can be naturally washed away by rainfall, reducing the required frequency for cleaning.

In the case of residential installations on the ground, make sure the system is installed following local regulations, e.g. using a fence.

AE Solar products have been tested and verified to be resistant to ammonia, sand, and salt mist corrosion.

Do not dispose of electrical appliances as unsorted municipal waste, use separate collection facilities. Contact your local government for information regarding the collection systems available.

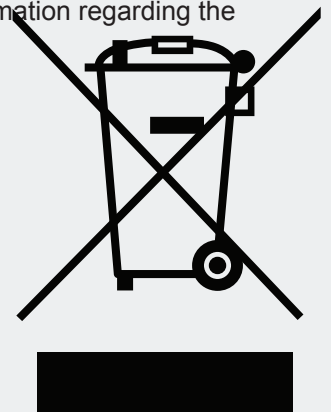

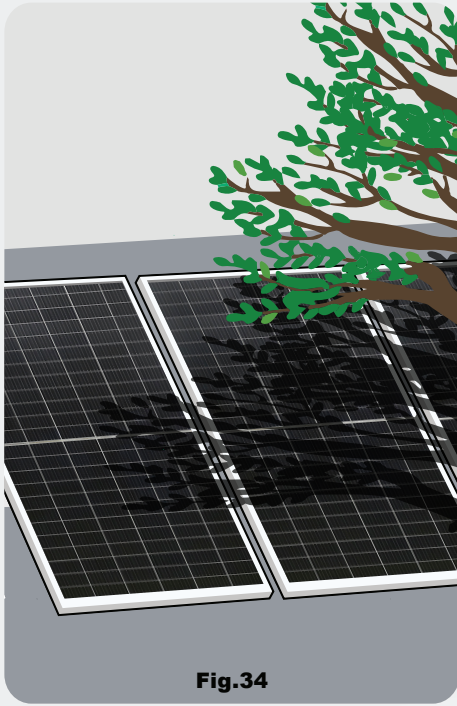

Fig.34

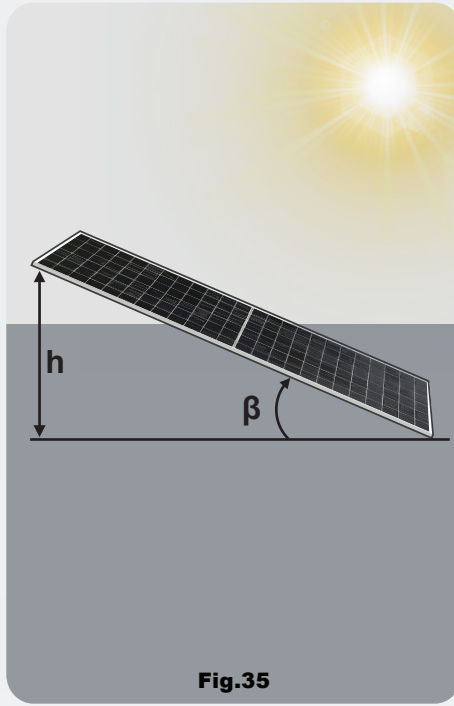

Fig.35

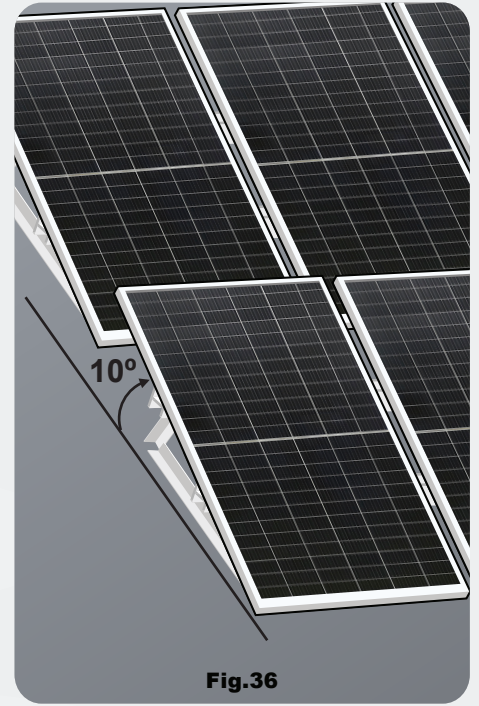

Fig.36

5.2. Mounting

All installation methods herein are only for reference, and AE Solar does not provide any related mounting hardware. The system installer is fully responsible for the PV system's design, installation, mechanical load calculations, and security.

The mechanical load-bearing limits (including wind and snow loads) of the modules are based on the following approved mounting methods. Please ensure modules are not subjected to wind or snow loads exceeding the maximum permissible loads and are not subject to excessive forces due to the thermal expansion of the support structures. Failure to follow the instructions in this manual may result in different capabilities to withstand snow and wind loads.

Any mounting system limitations on inclination or accessories required to maintain a specific system fire class rating should be clearly specified in the installation instructions and certifications of the mounting system supplier.

Please use a torque wrench for installation.

Do NOT drill additional holes or modify the module frame. Doing so will void the warranty.

AE Solar modules can be mounted in landscape or portrait orientation.

Regardless of the fixing method, make sure the minimum distance between two modules is at least 10mm to allow for thermal expansion of the frames.

The loads described in this manual correspond to test loads. For installations complying with IEC 61215-2:2016 and UL 1703 or IEC 61730, a safety factor of 1.5 should be applied for calculating the equivalent maximum authorized design loads. Project design loads depend on the construction, applicable standards, location, and local climate. For detailed information, please follow the local structural code or contact your professional structural engineer.

When installing modules, ensure the assembly is mounted over an appropriate fire-resistant roof surface rated for the application.

The fire rating for the modules is only valid when the product is installed as specified in the mechanical mounting instructions.

When installing modules on a roof, make sure to leave a clearance of at least 10cm between the module frame and the roof or wall surface for air circulation and heat dissipation. This allows an easier evaporation of condensation or moisture. Additionally, be sure to leave a safe working area between the edge of the roof and the external edge of the solar array.

Avoid blocking the drainage holes in the module frame during installation or use.

5.2.1. Fixed mounting system

The mounting of the modules onto a support structure can be done using one of the approved methods described below. For information about other installation methods, please contact your local representative. Failure to use a recognized installation method will void the AE Solar limited warranty.

5.2.1.1. Mounting with Bolts

The mechanical load tests with the following mounting methods were performed according to complete the IEC 61215-2:2021 standard. To maximize the mounting structure's lifetime, AE Solar recommends using corrosion-proof (stainless steel) fixtures.

The frame of each module has mounting holes placed to optimize the load handling capability, to secure the modules to the mounting structure. Please refer to the module datasheet for the number of holes, dimensions and placement.

Each module must be securely fastened at a minimum of 4 points on two opposite sides. Secure the module in each fixing location with an M8 bolt and a flat washer, spring washer, and a nut as shown in the figure and tighten to a torque of 16-20 Nm. The yield strength of bolt and nut should not be less than 450 MPa. The applied torque value should be big enough to fix the modules steadily. For special support systems or special installation requirements, please confirm with the mounting structure supplier the ideal torque value.

5.2.1.2. Mounting with Clamps

Please ensure the clamp thickness is at least 3mm and made of anodized aluminum alloy or stainless steel. AE Solar recommends using clamps with an EPDM or similar insulating washer, and at least M6 fixing bolts.

PV modules can be mounted onto the substructure using either corrosion-proof M8 bolts placed through the mounting holes on the rear of the modules or with specially designed module clamps.

All parts in contact with the frame should use flat stainless-steel **washers of at least 1.8 mm** thickness.

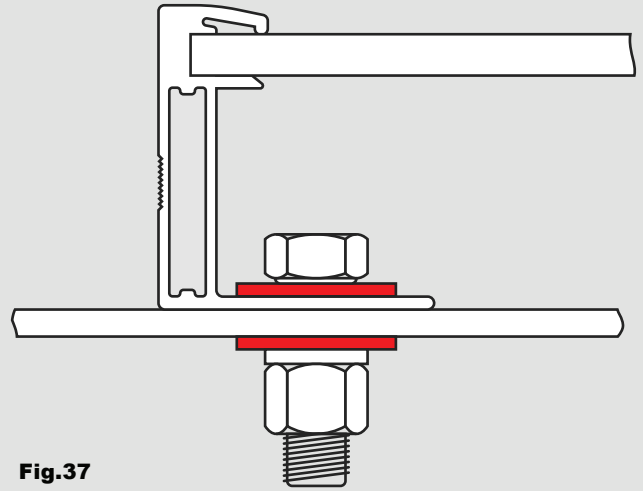

Fig.37

Top or bottom clamping methods will vary and are dependent on the mounting structures. Always follow the mounting guidelines recommended by the mounting system supplier.

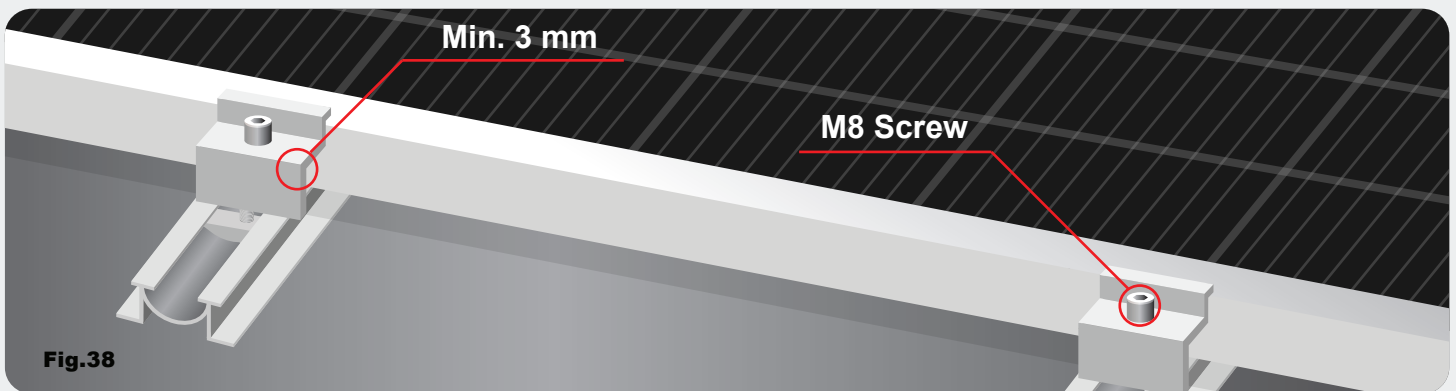

Fig.38

When fastening the clamps, they should not come into contact with the module's front glass or deform the frame. Please ensure there is no shading onto the module from the module clamps. The module frame is not to be modified under any circumstances. When installing with the clamp-mounting method, please be sure to use at least four clamps on each module. The clamps should

overlap the module frame by at least 10 mm but no more than 11 mm. A minimum of 4 clamps should be used to fix modules onto the mounting rails. Two clamps should be attached on each long side of the module (for portrait orientation) or each short side of the module (for landscape orientation). The clamps should be positioned symmetrically and in accordance with the authorized position ranges.

If excessive pressure loads are expected due to local wind and snow conditions, additional clamps or support may be required to ensure the modules can bear the respective loads. The applied torque value should be big enough to securely fix the modules. Please consult with the clamp or support supplier for the required torque values. The system designer and the installer are responsible for correctly calculating the loads and ensuring that the supporting structure meets all the applicable requirements.

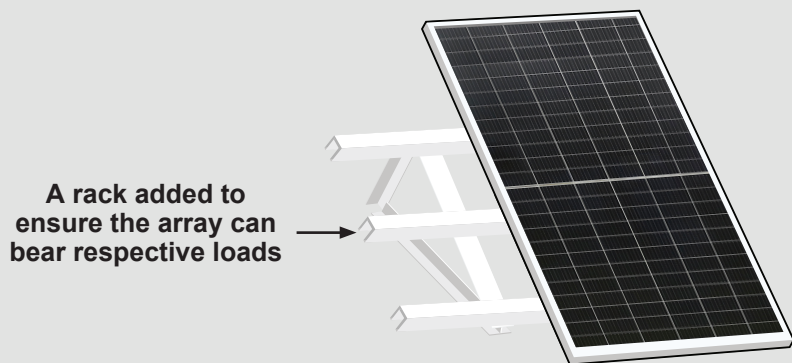

Fig.39

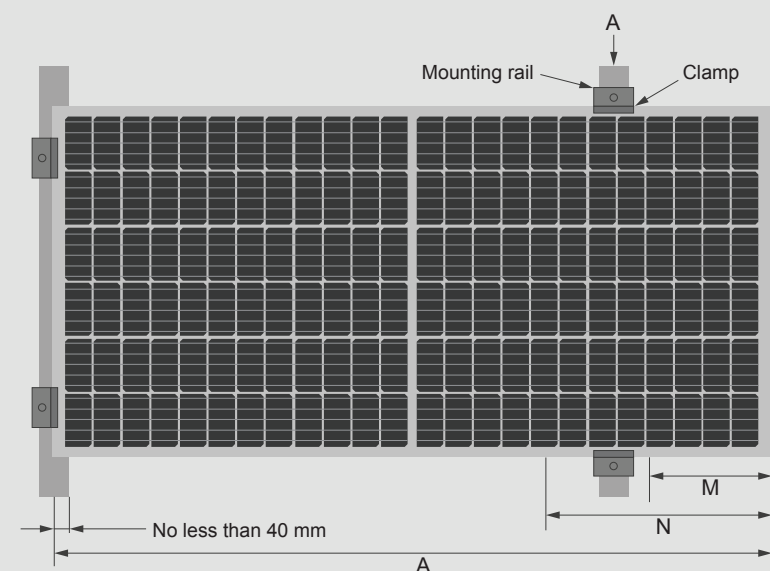

Fig.40

Table 1

Module Sizes (mm)	Mechanical loads:	
	Max. Long side Design Pressure: 3600 Pa (positive) & 1600 Pa (negative)	
	Max. Short side Design Pressure 1600 Pa (positive) & 1600 Pa (negative)	
	M (mm)	N (mm)
1718x1139x30	292	398
1721x1133x30	181	431
1754x1038x30	198	448
1811x1095x30	255	415
1898x1095x30	300	460
1902x1133x30	117	407
2094x1038x30	212	502
2094x1133x30	213	503
2171x1302x30	251	541
2278x1133x30	305	595
2383x1095x30	357	647
2383x1302x30	357	647
2464x1133x30	398	688
1692x996x30	166	416
1956x992x30	143	433
1979x996x30	155	445
2015x996x30	173	463
2020x996x30	153	403
1665x996x30	140	390
1480x670x30	165	415
1530x680x30	145	395
1650x992x30	165	415
1690x996x30	181	431
2171x1302x35	251	541
2383x1302x35	357	647
2383x1095x35	357	647

Table 2

Module Sizes (mm)	Module Types	Module Sizes (mm)	Module Types	Module Sizes (mm)	Module Types
1650x992x30	AEXXP6-60	1530x680x30	AEXXSMB-36	1956x992x30	AEXXP6-72
1480x670x30	AEXXP6-36	1690x996x30	AEXXSMB-60	2383x1302x35	AEXXTME-132BDS
1811x1095x30	AEXXBME-44E AEXXBME-44F	1979x996x30	AEXXMBS-72 AEXXMBS-72E	1665x996x30	AEXXMBS-60 AEXXMBS-60E
1721x1133x30	AEXXMDS-108BD AEXXMDS-108BS AEXXMDS-108 AEXXMDS-108E AEXXCMD-108 AEXXCMD-108BDS AEXXCMD-108E AEXXCMD-108BDE	2171x1302x30	AEXXMES-120BD AEXXMES-120BS AEXXMES-120	1898x1095x30	AEXXBME-46E AEXXBME-46F
2171x1302x35	AEXXTME-120BDS	2383x1302x30	AEXXMES-132BD AEXXMES-132BS AEXXMES-132	1754x1038x30	AEXXMC-120BD AEXXMC-120BS AEXXMC-120 AEXXMC-120E
1902x1133x30	AEXXMDS-120BD AEXXMDS-120BS AEXXMDS-120 AEXXMDS-120E AEXXCMD-120BDS AEXXCMD-120	2094x1038x30	AEXXMC-144BD AEXXMC-144BS AEXXMC-144 AEXXMC-144E	2383x1095x30	AEXXMES-110BD AEXXMES-110BS AEXXMES-110
		2278x1133x30	AEXXMDS-144BD AEXXMDS-144BS AEXXMDS-144 AEXXCMD-144BDS AEXXCMD-144	2383x1095x35	AEXXTME-110BDS
				2094x1133x30	AEXXMDS-132BD AEXXMDS-132BS AEXXMDS-132 AEXXMDS-132E

5.2.1.3. Mounting with Insertion Systems

Insertion systems come in different forms and methods can vary depending on the mounting structure. It is essential that the installer follows the guidelines recommended by the mounting system supplier. Each module must be securely maintained throughout all its width on two opposite sides. Install and tighten the insertion profiles to the support structure using the hardware and instructions provided by the mounting system manufacturer. The system designer and installer are solely responsible for load calculations and for the proper design of the support structure.

In case improper insertion systems or unsuitable installation methods are utilized, AE Solar's limited warranty may be voided. To avoid damaging the modules,

please take the following precautions into account when installing insertion profiles:

- **Do NOT** bend the module frame.
- **Do NOT** touch the front glass or cast shade onto it.
- **Do NOT** damage the surface of the frame.
- Please ensure that the insertion profiles overlap the module frame by at least 10 mm.
- Please ensure that the module frame (C-shape) overlaps the insertion profiles by at least 15 mm.
- Please ensure the insertion profile thickness and tolerances suit the module thickness.

5.2.2. Tracking mounting system

For single-axis tracking systems, the modules should be fixed onto the axis by bolting the long side of the frame. Please ensure the bolts are made of stainless steel or other anti-corrosion material.

Secure the module in each fixing location with M8 bolts, two flat washers, a spring washer, and a nut as shown. The bolts should be tightened to a torque of 16 - 20 Nm.

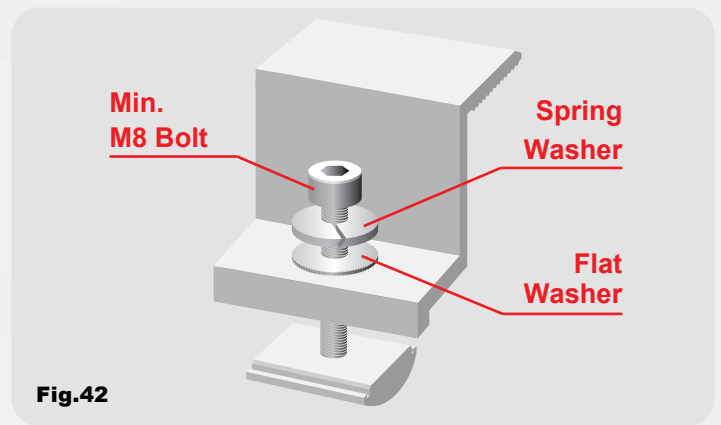
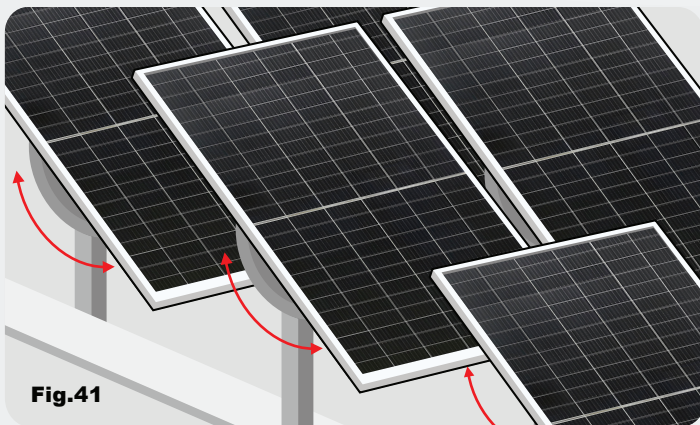

For single-axis tracking systems, the modules should be fixed onto the axis by bolting the long side of the frame. Please ensure the bolts are made of stainless steel or other anti-corrosion material. Secure the module in each fixing location with an M6 bolt, two flat washers, a spring washer, and a nut as shown in the figure. The bolts should be tightened to a torque of 16 Nm. All parts in contact with the frame should use flat stainless-steel washers of at least 1.5mm thickness.

6. ELECTRICAL CONNECTION

Solar modules generate electrical current and voltage even at a low intensity of illumination. Sparks and electric arcs may result from the separation of a closed circuit. These can result in life-threatening injuries. The danger increases when several modules are connected in series.

Please keep in mind that all the module's electrical ratings are measured under Standard Test Conditions, which are 1000 W/m² irradiance, AM 1.5 g spectrum, and 25°C ambient temperature. This means modules might produce more or less voltage or current than the rated value in real

operating conditions. For this reason, when calculating the rated voltage of equipment, the current carrying capacity of wires and fuses, and parameters associated with the output power of PV modules, the corresponding short-circuit current and open-circuit voltage should be applied with a safety factor of 1.25.

Please make sure to follow all the local regulations and safety guidelines for the installation of electrical devices and systems.

6.1. Sizing and interconnections

Before making any connections, ensure that all electrical components are in a proper, dry, and safe condition. Always check the module label to confirm the actual rating of your product before making connections.

Do NOT connect modules with different electric performance models in the same string in order to minimize any mismatch effects and losses in the arrays.

Please ensure that the modules are disconnected at the inverter prior to separation.

Do NOT open the junction box or remove bypass diodes from the module.

Modules can be wired in series to increase voltage or in parallel to increase current. When connecting modules in series, the resulting string voltage will be the sum of each individual module's voltage in the string. When connecting modules in parallel, the resulting array current will be the sum of each string's current. To connect modules in series, connect the cables from the positive terminal of one module to the negative terminal of the next module. To connect in parallel, connect the cables from the positive terminal of one module to the positive terminal on the next module.

6.2. Wiring

All wiring should be performed by qualified installers in accordance with local codes and regulations.

Only use dedicated solar cables and suitable connectors that meet local fire, building, and electrical regulations. Please ensure that all wiring is in perfect electrical and mechanical condition before making any connections.

An appropriate metal conductor material should be used for the wiring. Please select a suitable conductor gauge to minimize voltage drop and ensure that the conductor ampacity complies with all local regulations.

Please make sure to only connect cables with plugs. Only connectors of the same type and manufacturer should be connected together.

Do not clean or precondition the connectors using lubricants or any unauthorized chemical substances.

To ensure the normal operation of the system, make sure the polarity of the cables is correct when connecting modules or loads, such as inverters and batteries. If the PV module is not connected correctly, its bypass diodes may be damaged. Modules can also be irreversibly damaged if an array string is connected in reverse polarity to another.

Always verify the voltage and polarity of each individual string before making a parallel connection. If you measure a reversed polarity or a difference of more than 10 V between strings, please check the string configuration before making the connection.

Avoid forming loops with the wiring design to minimize the risk of a direct lightning strike on the system.

Secure the cables to the mounting system using UV-resistant cable ties. Ensure that the cabling is not

The open-circuit voltage of each string must not exceed the maximum system voltage value under the lowest expected temperature conditions. AE Solar modules can tolerate a maximum system voltage of DC 1500 V, depending on the model (please refer to the module datasheet for the correct product specification). The actual system voltage should be designed based on the selected inverter model.

The number of allowed modules connected in series on a string can be calculated with the following formula:

$$\text{Max. system voltage} > N \cdot V_{oc} [1 + \beta (T_{min} - 25)]$$

N: Number modules connected in series;

V_{oc}: Open-circuit voltage of each module (refer to the product label or datasheet);

β: Thermal coefficient of open-circuit voltage for the module (refer to datasheet);

T_{min}: The lowest expected ambient temperature on site.

When modules have been pre-installed, but the system has not been connected to the grid yet, each module string should be kept under open-circuit conditions and proper actions should be taken to avoid dust and moisture penetration inside the connectors.

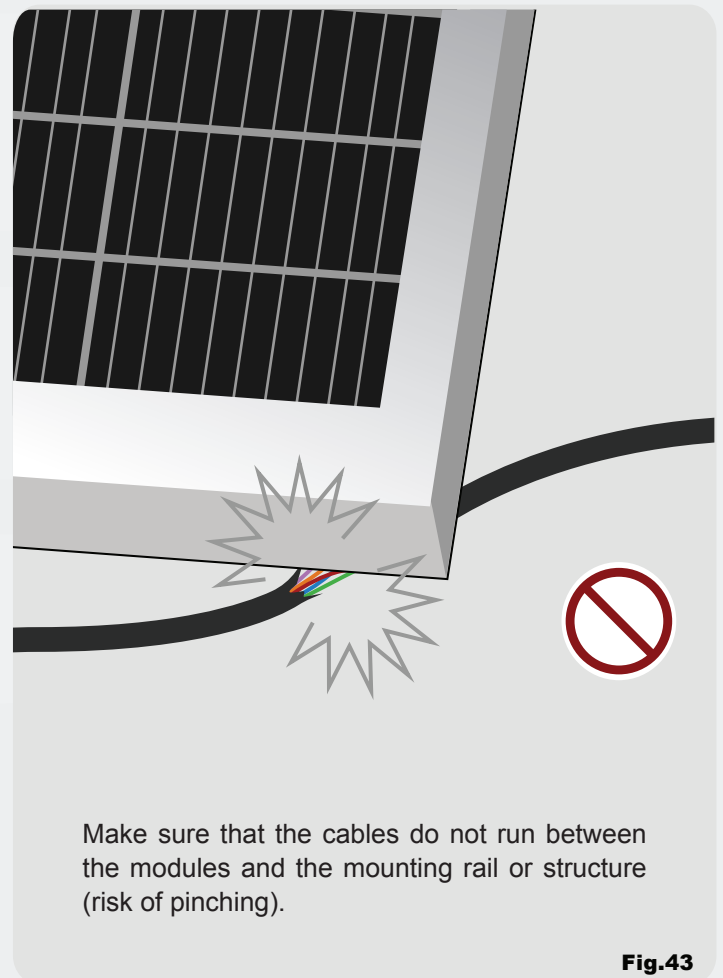

Fig.43

exposed and /or hanging and is protected from dirt, moisture, direct sunlight, and mechanical friction. Protect any exposed cables from damage by taking appropriate precautions. Please make sure that the plug connections are positioned away from any water-channeling surface.

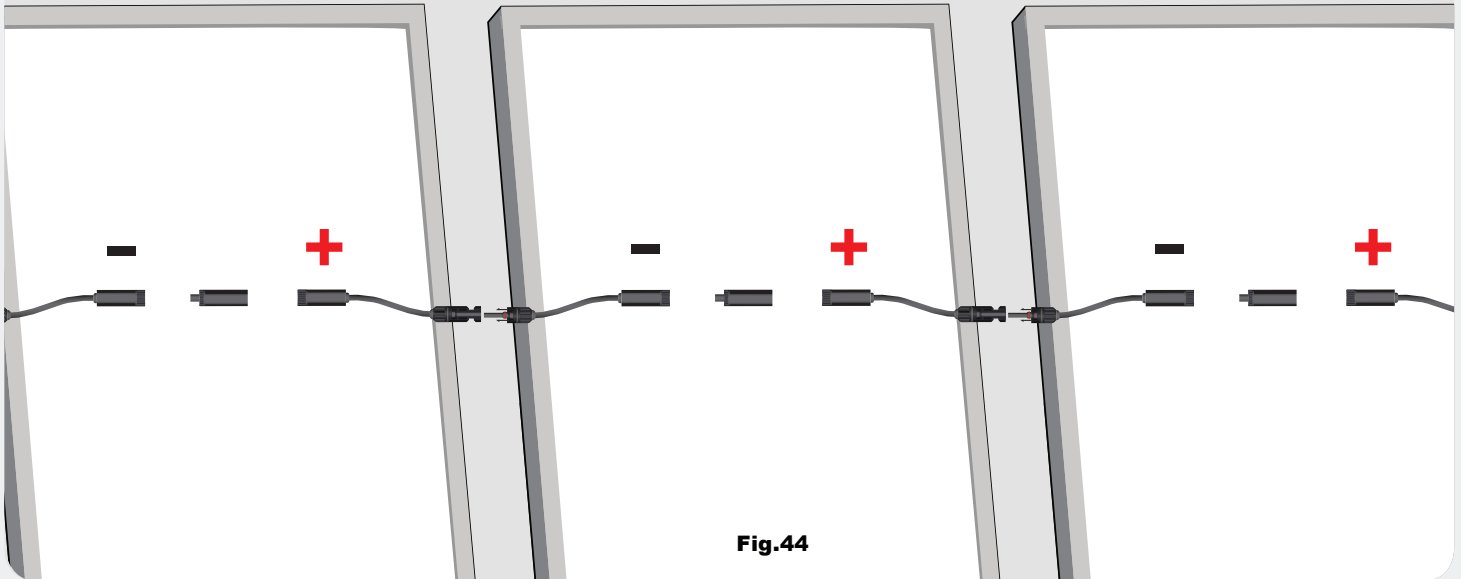

Fig.44

Please ensure that the wiring is correct before starting up the system. If the measured open-circuit voltage (V_{oc}) and short-circuit current (I_{sc}) differ from the specifications, this could indicate a wiring fault.

It is recommended to use a suitably rated isolator (DC switch) to interrupt the current flow before disconnecting any connectors.

6.3. Fusing

Two or more module strings should only be connected in parallel if an appropriate and certified over-current protection device is installed in series within each string. Please make sure that the reverse current of any particular string is lower than the module maximum fuse rating under any circumstances.

The actual module-specific rating should be consulted on the product label and in the product datasheet. This fuse rating value also corresponds to the maximum reverse current that a module can withstand, i.e. when one string is shaded. In this situation, the other parallel strings will be affected by the shaded string and some of the current will pass through them to compensate for the difference in string voltage.

When fuses are fitted, they should be rated for the maximum DC voltage and connected to each non-grounded pole of the array (i.e. if the system is not grounded then fuses should be connected in both the positive and negative poles).

6.4. Grounding

All module frames and mounting racks must be properly grounded in accordance with appropriate local regulations. Any grounding connections should be installed by a qualified electrician, and modules frames should be connected together using adequate grounding cables. Holes provided for this purpose are identified with a grounding symbol. All conductive connection junctions must be firmly fixed. Proper grounding is achieved by bonding the module frames and all metallic structural members together continuously using a suitable grounding conductor.

The grounding conductor or strap may be copper, copper alloy, or any other material acceptable for use as an electrical conductor per the respective local electrical codes. The grounding conductor must then make a connection to the earth using a suitable ground electrode. Attach the equipment grounding conductor to the module frame using the hole and hardware provided. Make sure the grounding device is in full contact with the interior of the aluminum alloy of the frame, penetrating the surface oxide film. Note that a stainless-steel star washer is used between the ground wire and module frame. This washer is used to avoid corrosion due to dissimilar metals. Tighten the screw securely.

Do NOT drill any extra ground holes onto the module as this will void its limited warranty.

If any third-party grounding devices are utilized, make sure to install them in accordance with the manufacturer's specified instructions. In case, there are already existing lightning protection systems in place, please make sure to integrate the system in accordance with the applicable local regulations.

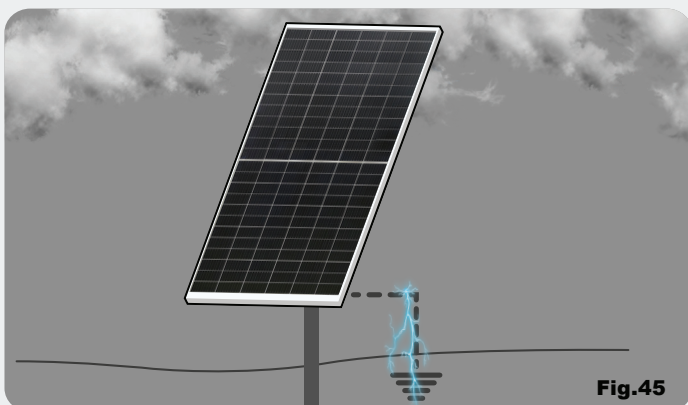

Fig.45

7. SOLAR PV INSTALLATION CHECKLIST

During installation, AE Solar recommends using the following checklist to ensure no essential steps are overlooked:

Before Testing the System

- Use proper safety procedures and equipment when working with electricity.
- Verify that all disconnects are locked in the open position with a warning label. This ensures that power cannot travel further down the line until properly tested, and warns others that there may be live conductors in the box.

PV Array

- Make sure all modules are attached securely to their mounting brackets.
- Visually inspect the array for cracked modules, damaged junction boxes, and loose wires.
- Visually inspect that all module 'quick connects' are tight.
- Open each combiner box and test open circuit voltage on each series string to verify the correct voltage and polarity. Recheck torque on all DC terminals.
- Before powering up the system, at final array breakers, repeat open circuit voltage tests to verify correct voltage and polarity.
- Verify modules are wired so that they can be removed without interrupting the grounded conductor.

Wiring

- Check exposed array wiring for correct electrical rating and sunlight resistant insulation.
- Check that all wiring and conduit are appropriately rated, neat, and well supported.
- Check that strain reliefs/cable clamps are correctly installed.
- Verify that all junction boxes are accessible.

Over-current Protection

- Verify that the overcurrent device rating of the PV circuit is at least 156% of the rated short.
- Make sure DC voltage and current ratings are clearly marked on over-current protection.

Charge Controllers

- Fasten all terminations again.
- Check that all voltage settings are correctly set for the appropriate battery type and proper voltage.
- If the system is connected to a utility-interactive inverter, make sure that the settings of the charge controller(s) do not interfere with the proper operation and dispatch of the inverter system.
- Verify that the charge controller operation matches the programmed settings by forcing the system to the setpoints and making sure that the unit performs the proper control function.

Disconnects

- Verify that the disconnects are still locked open and the warning label is still intact.
- Verify that there are means to disconnect and isolate all pieces of equipment in the system.
- If fuses are used, verify means to disconnect the power from both ends.
- Ensure switches are accessible and clearly labeled.
- Check the continuity of fuses and circuit breakers with power off.
- Check voltage drop across switches while operating.
- Check individual cell or battery voltages after equalization.
- Check the specific gravity of all questionable cells with a hydrometer.

Grounding

- Verify that only one connection in the DC circuits and one connection in the AC circuits (grounded conductor to grounding conductor) is being used for system grounding referenced to the same point.
- Check to see that equipment grounding conductors and system grounding conductors have as short a distance as possible to ground.
- Check that non-current carrying metal parts are grounded properly (array frames, racks, metal boxes, etc.).
- Check resistance of the grounding system to earth ground.
- Verify that the equipment grounding conductor is a green or bare wire and is properly sized.

Safety Signs

- Label any fuse or circuit breaker that can be energized in either direction.
- Post an "Interactive Point of Connection" sign for interactive PV system.
- Post a "No Smoking" sign near the batteries.
- Place a sign at the point of PV system disconnect listing: operating current, operating voltage, maximum system voltage, and short-circuit current.

8. MAINTENANCE

8.1. Cleaning

It is the responsibility of the user to carry out regular inspection and maintenance of the modules, especially during the period of the limited warranty.

Regular maintenance is required to keep modules clear of soiling, such as (but not limited to) snow, bird droppings, seeds, pollen, leaves, branches, dirt spots, and dust. If installed with sufficient tilt (at least 15°), dirt and grime can often be washed away by rain, removing the need for regular cleaning. If the module is fully or partially shaded by dirt or debris (e.g., plants, bird droppings), it should be cleaned to prevent a loss of performance.

To minimize the risk of electrical shock or burn, the cleaning of the modules should be done in the early morning or evening, with low irradiance conditions and low module temperature.

Please ensure that the circuit is disconnected before initiating the cleaning procedure. Keep in mind that any contact with electrically active parts can result in electrical shock and injury.

Make sure to wear suitable protection (clothes, insulated gloves, etc.) for the cleaning procedure.

Before cleaning, thoroughly inspect modules for cracks, damage, and loose connections. Cracked or damaged modules may represent an electric shock hazard due to leakage currents, and the risk of shock is increased when modules are wet.

Do NOT attempt to clean modules with damaged glass or exposed wires

Rinse any dirt (dust, leaves, etc.) off with lukewarm water.

Do NOT use abrasive cleaners, de-greasers, or any unauthorized chemical substance (e.g. oil, lubricant, pesticide, etc.) on the module.

Do NOT use cleaning corrosive solutions containing hydrofluoric acid, alkali, acetone, or industrial alcohol.

Application of any cleaning method which requires rotary brushes, robot cleaners, or string cleaners should be first discussed and verified by AE SOLAR. Uncertified devices might lead to abrasion on the glass surface, removal of the anti-reflection coating and consequently power loss, formation/propagation of micro-cracks due to the weight and vibrations of the devices, etc.

In case of automated cleaning devices (e.g. robots), they should move on top of the module frames and not over the module glass. This is especially important for larger modules.

Lower weight cleaning robots with larger surface areas lead to better weight distribution and reduce possibilities of module defects induced by mechanical stress. The brushing direction should be opposite to the robot's movement to reduce the possibility of abrasion.

Do NOT attempt to clean modules with water if there is a risk of frost.

Do NOT scrape or attempt to rub dry dirt away, as this may cause micro scratches.

Neutral pH water with low mineral content is recommended to clean the modules. Water with high mineral content may leave deposits on the glass surface after drying, and strong acid or alkali water may cause damage to the glass coating layer.

A soft cloth, sponge, or brush with soft bristles can be utilized to carefully remove stubborn dirt. Please make sure that the utilized tools are not abrasive to glass, EPDM, silicone, aluminum, or steel.

Do NOT use micro-fleece wool or cotton cloths.

Snow should be removed with the aid of a soft brush.

Normally the rear side of the module requires no cleaning. In case that the cleaning of the rear side is necessary, please avoid using any sharp objects that may scratch or damage the backsheets.

Do NOT submerge the module, partially or totally, in water or any other cleaning solution.

Any damages caused by inappropriate cleaning procedures will void AE Solar's limited warranty.

8.2. Visual Inspection (checklist)

The inspection of the PV system should be done regularly by qualified personnel.

This should be carried out at least once a year, although the recommended frequency and thoroughness of inspections may vary with local circumstances (e.g. salt, ammonia content in the air, high humidity, etc.).

Inspections are especially important after extraordinary events (e.g. storms, hail, high snow loads, etc.).

During the inspections, all system components should be checked to ensure they are secure, undamaged, and clean. The following checklist can be consulted to ensure all relevant components are properly inspected:

PV SYSTEM - MAINTENANCE CHECK LIST

Array Installation and Wiring

- Condition
- Proper insulation on module wiring
- Proper connectors on array wiring extensions
- Proper grounding of array & array mount
- Grounded conductors installed
- Array mount properly secured and sealed
- Damages of modules observed
- Dirt accumulation observed
- Shading observed on modules

Installation:

Inspector by:

Date:

DC Connections

- Source Circuit Combiner Boxes
- DC-rated circuit breakers or fuses with adequate voltage rating

DC Component Enclosures

- Proper conductor sizes and insulation types
- Proper conductor terminations
- DC ratings on DC components
- SINGLE POINT GROUNDING!

AC Component Enclosure

- Isolated Neutral busbar
- Labelled disconnects and C/B

Utility Disconnect

- Visible, lockable, accessible, load break, external handle

Appropriate Signs installed

- Check for sign identifying PV power source system attributes at D.C. disconnect
- Check for sign identifying A.C. point of connection
- Check for sign identifying switch for alternative power system.